

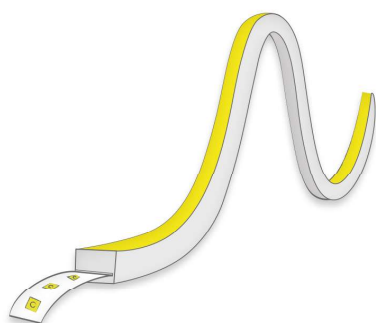

Fita Led Neon Up NESO

Ficha Técnica

Fita LED Neon Up NESO 24V 10W IP67



Acessórios para fita neon UP:



Tampa final
(Ref.: 2219243)



Conector
(Ref.: 2220243)

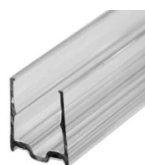

Calha fixadora
PL 1mt
(Ref.: PF148PL)



Fixador 1010
(Ref.: 2226143)



Calha fixadora
AL 1mt
(Ref.: PF148AL)

. Inclui 1 conector em cada topo

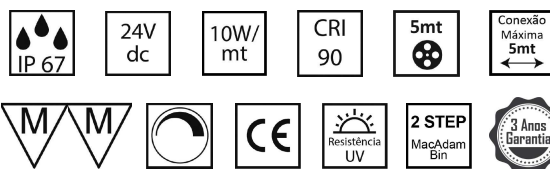

Exemplos de Aplicação	Debaixo de bancos de jardim Parede de revestimento (por ter dimensões reduzidas)
Tensão	24Vdc
Potência	10W
Lumens	2700K - 702Lm/m 3000K - 772Lm/m 4000K - 777Lm/m
CRI	90
Grau de Estanqueidade	IP67
Intervalo de Temperatura em funcionamento	-20º ~ 50º
Temperatura de Cor	2700K / 3000K / 4000K
Modelo	Neon UP NESO

Referência	Cor de Luz	Lumens /mt	C x L x A (mm)
1322136.1027	2700K	702 Lm	35,7 x 10 x 10
1322136.1030	3000K	772 Lm	35,7 x 10 x 10
1322136.1040	4000K	777 Lm	35,7 x 10 x 10

Dimensões:

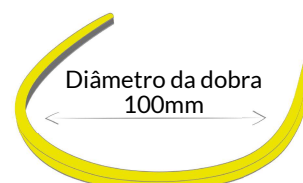
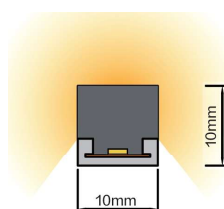
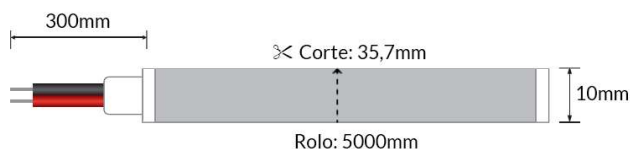

LED NEON UP NESO

Instruções

1. A temperatura de operação mais adequada deve ser de -25°C a 45°C .

2. Certifique-se de que, mesmo durante a instalação, a direção de dobra predeterminada nunca muda. O produto é apenas para dobra SUPERIOR e não pode ser torcido ou dobrado lateralmente.

3. LED NEON UP NESO não deve ser dobrado brusca-mente e pode causar danos ao produto.

4. O diâmetro máximo de curvatura é de 50 mm, a curvatura excessiva danificará e anulará qualquer garantia.

5. Durante a instalação, o LED NEON UP NESO não pode ser:

- Torcido
- Deixado cair
- Dobrado em um ângulo de 90° ou totalmente dobrado
- Pendurado

6. Certifique-se de que o produto não grude em nenhum material relacionado ao papel diretamente.

7. Para instalação, 2 formas para sua seleção.

- Clipes de montagem
- Perfil de Plástico

8. Instale o produto no perfil com cuidado e corretamente, retirando e remontando provavelmente causará danos ao produto.

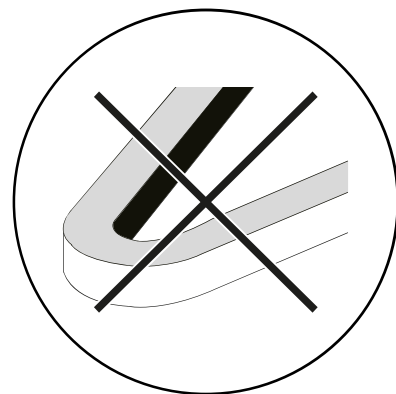
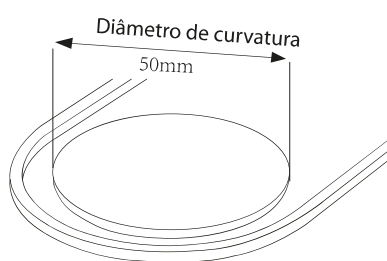
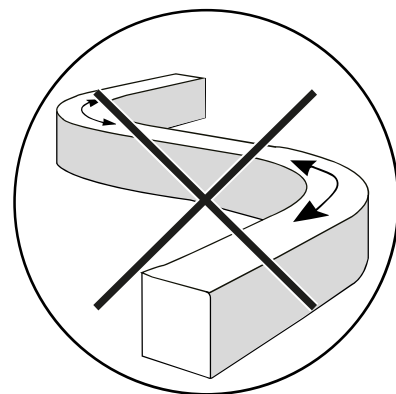
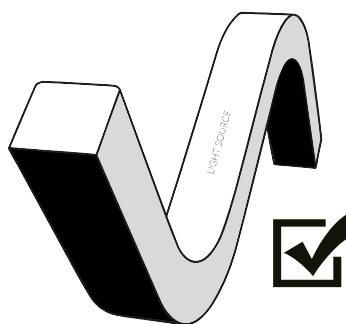
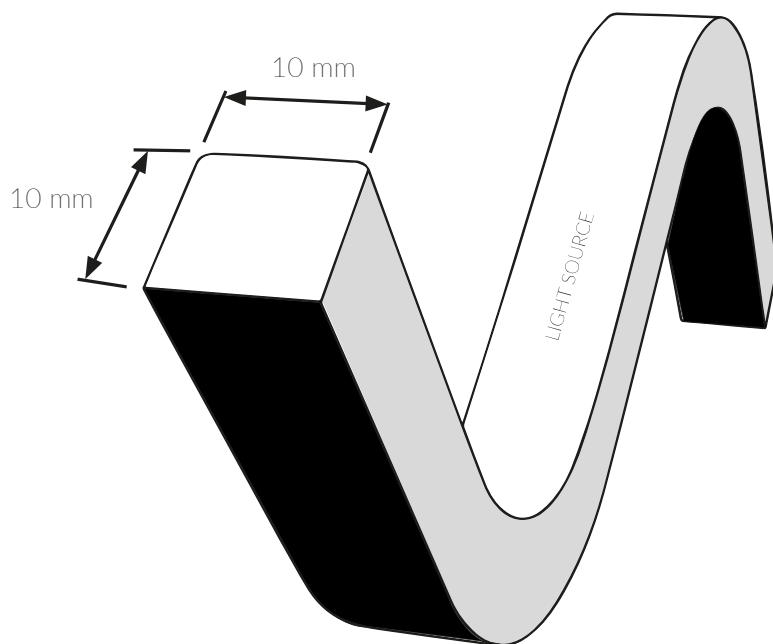

Não fazer ângulos apertados

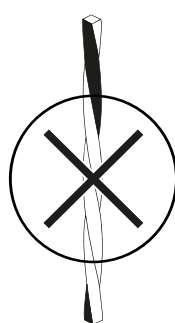

Não torcer

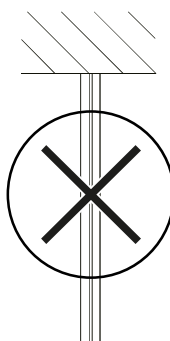

Não pendurar

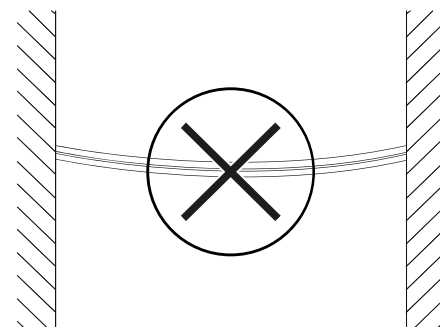

Não deixar caído

