



SELEÇÃO DE PRODUTOS

MOTAKO

ICONOGRAFIA

ICONOGRAFÍA

Ao longo de todo o catálogo encontrará vários ícones referentes às propriedades de cada produto.

A lo largo de todo el catálogo encontrarás diversos iconos referentes a las propiedades de cada producto.

CARACTERÍSTICAS DO PRODUTO

CARACTERÍSTICAS DEL PRODUCTO



Nova tecnologia, R2R - Rolo a Rolo. As fitas contêm um PCB contínuo, sem uniões de soldadura.
Nueva tecnología, R2R (rollo a rollo). Las cintas contienen una PCB continua, sin uniones soldadas.



Eficiência Energética
Alta Eficiencia



Potência
Potencia



Tensão
Tensión



Corrente
Corriente



Índice de Proteção
Índice de Protección



Índice cromático da luz
Índice cromático de la luz



Tipo de LED
Tipo de LED



Quantidade de LED por metro
Número de LED por metro



Comprimento do rolo de fita led
Longitud del rollo de tira LED



Ligação máxima de fita
Conexión máxima de tira



O nosso serviço HIL: produção de neons e luminárias de alta proteção e alto impacto
Nuestro servicio HIL: producción de neones y luminarias de alta protección y alto impacto.



Temperatura de funcionamento
Temperatura de funcionamiento



Dimável ou não dimável
Regulable o no regulable



Comando por radiofrequência, USB ou wifi
Control por radiofrecuencia, USB o wifi



Direção de luz
Dirección de la luz



Material: Alumínio, cerâmica, aço inoxidável, plástico, inox, vidro, plástico (ABS), policarbonato
Material: Aluminio, cerámica, acero inoxidable, plástico, vidrio, plástico (ABS), policarbonato



Com possibilidade de corte à medida
Posibilidad de corte a medida





Dimensão do corte para perfis de encastramento
Dimensión de corte para perfiles empotrados

INFORMAÇÕES DE SEGURANÇA TÉCNICA

INFORMACIÓN TÉCNICA DE SEGURIDAD

	Densidade da fita de LED <i>Densidad de tira de LED</i>
	Fator potência <i>Factor de potencia</i>
	Ângulo de abertura <i>Ángulo de apertura</i>
	Resistência aos raios UV <i>Resistencia a los rayos UV</i>
	Durabilidade <i>Durabilidad</i>
	Fonte de alimentação ventilada <i>Fuente de alimentación ventilada</i>
	Aplicação: parede, teto <i>Aplicación: pared, techo</i>
	Instalação Interior / Exterior <i>Instalación Interior / Exterior</i>
	Capacidade de resistir ao contato com água salgada <i>Capacidad para resistir el contacto con agua salada</i>
	Capacidade de resistir ao contato com componentes químicos <i>Capacidad para resistir el contacto con componentes químicos</i>
	Equipamento contra-harmônicas, com fator de correção de potência ativo <i>Equipos contraarmónicos, con corrección activa del factor de potencia</i>
	Equipamento programável através de dip-switch <i>Equipos programable mediante dip-switch</i>
	Capacidade de resistir à exposição solar <i>Capacidad para resistir la exposición al sol.</i>
	Possibilidade de submersão em água até 2mt <i>Posibilidad de inmersión en agua hasta 2mt</i>

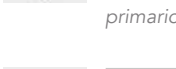
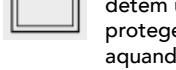
	Equipamento com ligação de terra / Equipamento sem ligação de terra <i>Equipos con conexión a tierra / Equipo sin conexión a tierra</i>
	Baseado na VDE0710-14, pode ser instalado dentro de um material inflamável tal como uma caixa de madeira. Determina a distância mínima entre a fonte e os laterais da caixa inflamável. <i>Basado en VDE0710-14, se puede instalar dentro de un material inflamable como una caja de madera. Determina la distancia mínima entre la fuente y los lados de la caja inflamable.</i>
	Proteção contra excesso de aquecimento para prevenir que a caixa em nenhum momento possa superar os 100°C / 110°C / 120°C, de modo a evitar possíveis incêndios. <i>Protección contra sobrecalentamiento para evitar que la caja supere los 100°C / 110°C / 120°C en cualquier momento, para evitar posibles incendios.</i>
	Adequado para montar directamente sobre superfícies inflamáveis tais como madeira (>2mm) <i>Apto para montaje directo sobre superficies inflamables como madera (>2 mm)</i>
	Enrolamentos separados (proteção no transformador entre o primário e o secundário) <i>Devanados separados (protección en transformador entre primario y secundario)</i>
	Proteção a isolamento de classe 2. O equipamento detém uma dupla camada de isolamento elétrico protegendo assim de um eventual choque elétrico aquando do contato físico com a parte elétrica do equipamento. <i>Protección de aislamiento clase 2. El equipo dispone de doble capa de aislamiento eléctrico, protegiéndolo así de posibles descargas eléctricas al entrar en contacto físico con la parte eléctrica del equipo.</i>
	Grau de proteção ao impacto
	Conformidade com as diretivas legais vigentes na Europa <i>Cumplimiento de las directivas legales vigentes en Europa</i>
	Numa fonte com o SELV integrado, a ocorrência de falhas não irá resultar em choques elétricos, pois está eletricamente separado da terra e dos outros sistemas e incorpora isolamentos elétricos adequados. <i>En una fuente de alimentación con SELV integrado, las fallas no provocarán descargas eléctricas, ya que está separada eléctricamente de la tierra y de otros sistemas e incorpora un aislamiento eléctrico adecuado.</i>

SERVIÇOS E PERSONALIZAÇÃO

SERVIÇOS MOTAKO

ESCOLHA O SERVIÇO QUE MELHOR SE ADAPTA AO SEU PROJETO:

- Personalização de fitas Neon, fitas Led e Perfis
- Desenvolvimento de Luminárias à medida
- HIL – Luminárias de Alto Impacto

Se pretende iluminação personalizada,
escolha os produtos e nós tratamos do resto!

ELIJA EL SERVICIO QUE MEJOR SE ADAPTE A SU PROYECTO

- Personalización de cintas de Neón, cintas Led y Perfiles
- Desarrollo de Luminarias a medida
- HIL – Luminarias de Alto Impacto

Si desea una iluminación personalizada,
elija los productos y nosotros nos encargamos del resto.

PERSONALIZAÇÕES

FITAS NEON / TIRAS NEÓN



Medida personalizável / Medida personalizable



Vulcanização / Vulcanización



Tamponagem / Tamponaje

FITAS LED / TIRAS LED



Corte de fita / Corte de tira



Personalização de cabo / Personalización del cable



Soldadura / Soldadura

PERFIS / PERFILES

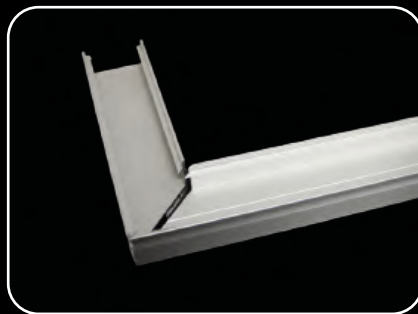
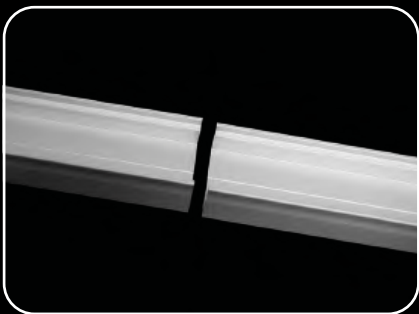

Corte de perfis / Corte de perfiles

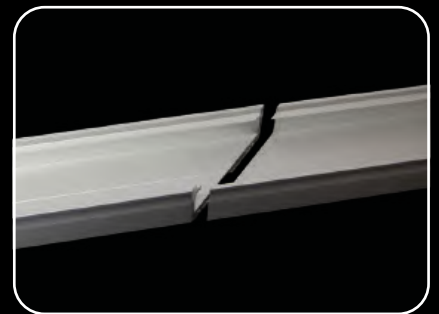

NEON HIL

Modelos disponíveis para personalização:

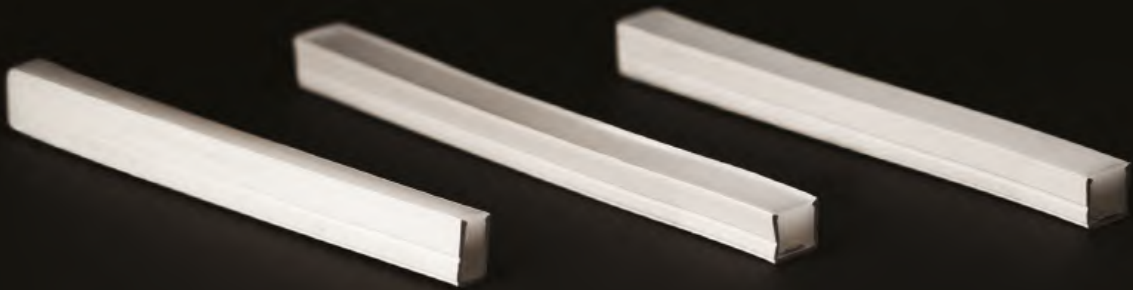
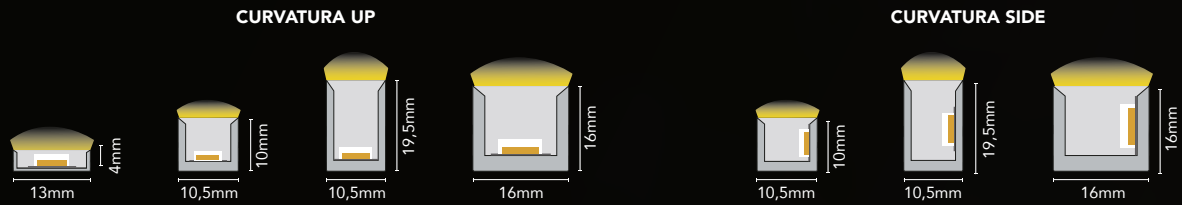

LUMINÁRIA HIL

Modelos disponíveis para personalização:

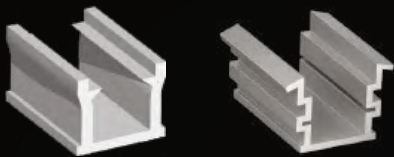

Possibilidade de encher uma grande variedade dos nossos perfis.*

*Sob consulta.





UM NOVO SERVIÇO MOTAKO

HIL - HIGH IMPACT LIGHTING

O seu projeto de sonho, a nossa especialidade. Produzimos neons e luminárias HIL totalmente à medida das suas necessidades.

OPÇÕES DE PERSONALIZAÇÃO

TEMPERATURA:

- _2700K, 3000K, 4000K, 6000K
- _RGB, RGBW e CCT.

OPACIDADE:

- _Transparente
- _Opalino

ACABAMENTO:

- _Soft
- _Rígido (disponível apenas para luminária)

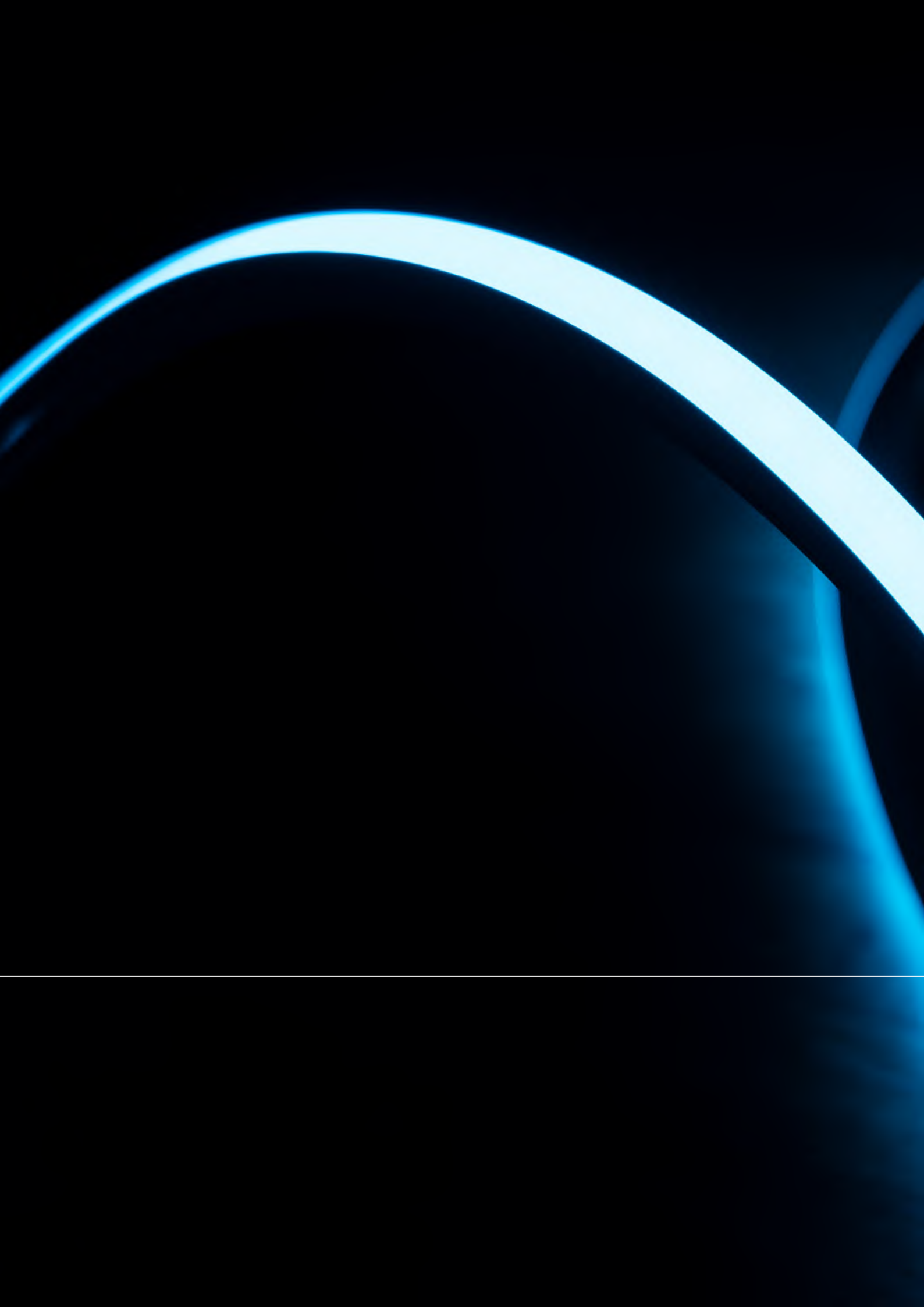



FITA LED NEON

Tira Led Neón

NEON UP SETEBOS - PISCINA IP68

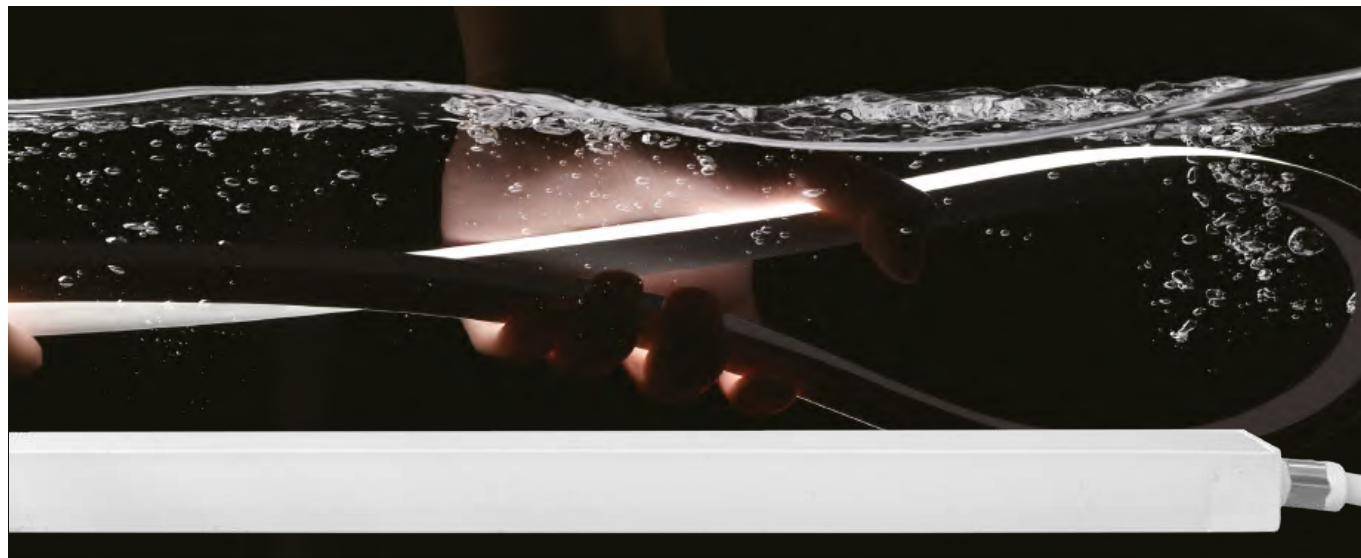

FITA LED NEON



Modelo	Ref.	Cor Color	Tensão Tensión	Lumens /mt	Potência /mt	Rolo Rollo
	136.0527	2700K	24V	240Lm	5W	20mt
	136.1027	2700K	24V	480Lm	10W	15mt
	136.1527	2700K	24V	720Lm	15W	12mt
	136.0530	3000K	24V	245Lm	5W	20mt
	136.1030	3000K	24V	490Lm	10W	15mt
	136.1530	3000K	24V	735Lm	15W	12mt
	136.0540	4000K	24V	270Lm	5W	20mt
SETEBOS NEON UP	136.1040	4000K	24V	540Lm	10W	15mt
	136.1540	4000K	24V	810Lm	15W	12mt
	136.0565	6500K	24V	250Lm	5W	20mt
	136.1065	6500K	24V	500Lm	10W	15mt
	136.1565	6500K	24V	750Lm	15W	12mt
	136.07RGB	RGB	24V	172Nm	7W	15mt
136.09RGB	RGB	24V	233Nm	9W	13mt	
136.12RGB	RGB	24V	311Nm	12W	12mt	



ACESSÓRIOS RECOMENDADOS
 ACCESORIOS RECOMENDADOS

Calha fixadora PL 1mt
 Perfil de fijación PL 1mt
 Ref. PF196PL



Calha fixadora para encastrar PL 1mt
 Perfil de fijación empotrado PL 1mt
 Ref. PF296PL



Fixador 1617
 Fijador 1617
 Ref. 2226272

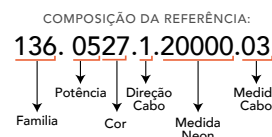
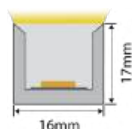
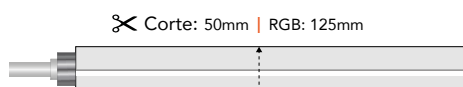

Este modelo tem disponível as seguintes saídas de cabo: | Este modelo dispone de las siguientes salidas de cable:



Fita sob encomenda. Tira por encargo.

CARACTERÍSTICAS DE PERSONALIZAÇÃO
 FUNCIONES DE PERSONALIZACIÓN

- a. Comprimento da fita neon. Longitud de la cinta de neón.
- b. Comprimento do cabo. Tamaño del cable.
- c. Direção do cabo. Dirección del cable.

Medida de rolo disponível até 20mt. Tamaño de rolo disponible un máximo de 20 metros.

NEON UP NESO 10W IP67





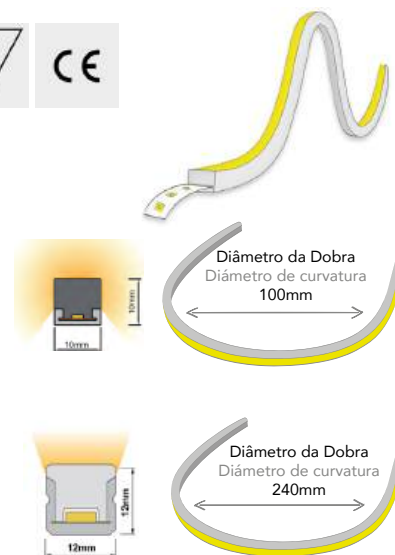







Modelo	Ref.	Cor Color	Tensão Tensión	IP	Lumens /mt	Lumens /w
NESO L70B10 54000H 2 Steps MacAdam	1322136.1027	2700K	24V	IP67	740Lm	74Lm
	1322136.1030	3000K	24V	IP67	790Lm	79Lm
	1322136.1040	4000K	24V	IP67	830Lm	83Lm
L80 30000H 1BIN	1368136.10RGB	RGB	24V	IP67	R: 330Nm G: 920Nm B: 175Nm	R: 33Nm G: 92Nm B: 17,5Nm



Este modelo standard tem saída de cabo de topo.

Este modelo estándar tiene una salida de cable superior.

ACESSÓRIOS RECOMENDADOS | ACCESORIOS RECOMENDADOS

<p>Conector Ref. 2220243</p> 	 <p>300mm Corte: 35,7mm Rolo: 5000mm</p>	 <p>300mm Corte: 62,5mm Rolo: 5000mm</p>				
<p>Fixador 1010 Fijador 1010 Ref. 2226143</p> 	<p>Tampa final Tapa final Ref. 2219243</p> 	<p>Calha fixadora Perfil de fijación PL 1mt Ref. PF148PL</p> 	<p>Calha fixadora Perfil de fijación AL 1mt Ref. PF148AL</p> 	<p>Fixador 1212 Fijador 1212 Ref. 2226162</p> 	<p>Tampa final Tapa final Ref. 2219657</p> 	<p>Calha fixadora Perfil de fijación AL 1mt Ref. PF149AL</p> 

NEON UP NAMAKA 10W IP67

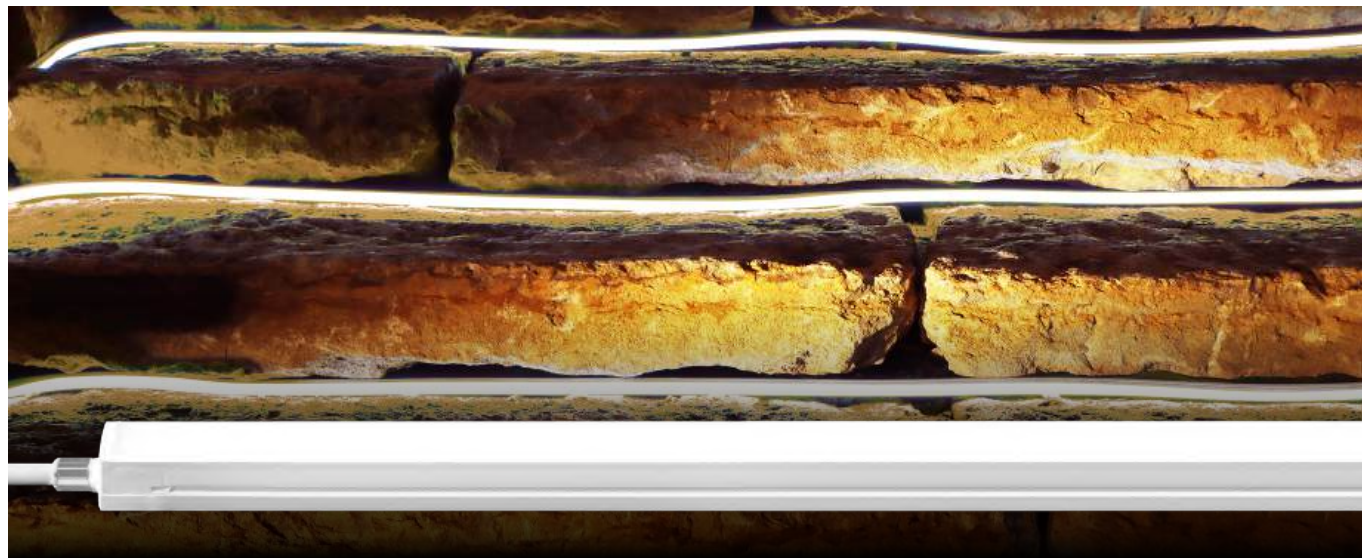

FITA LED NEON



Modelo	Ref.	Cor Color	Tensão Tensión	IP	Lumens /mt	Lumens /w
NAMAKA L70B10 50000H 2 Steps MacAdam	132246.1027	2700K	24V	IP67	536Lm	54Lm
	132246.1030	3000K	24V	IP67	551Lm	55Lm
	132246.1040	4000K	24V	IP67	536Lm	54Lm

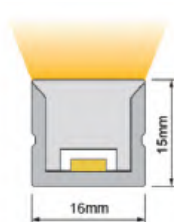
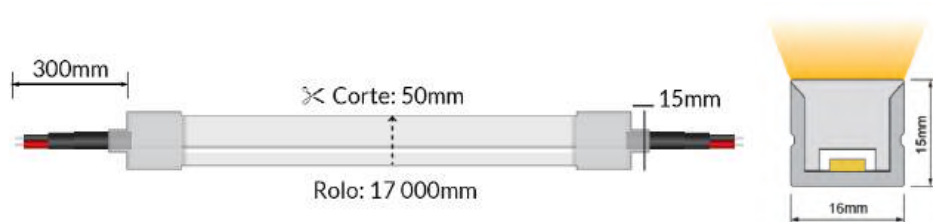
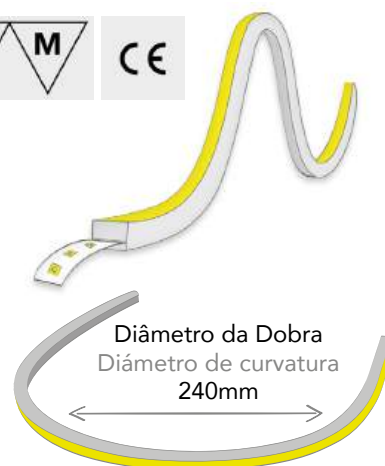

Este modelo standard tem saída de cabo de topo.
Este modelo estándar tiene una salida de cable superior.



ACESSÓRIOS RECOMENDADOS | ACCESORIOS RECOMENDADOS

Tampa final Tapa final Ref. 2219244	Tampa final Tapa final Ref. 2219253	Conector Ref. 2220244.RGB	Calha fixadora PL 1mt Perfil de fijación PL 1mt Ref. PF152PL	Calha fixadora AL 1mt Perfil de fijación AL 1mt Ref. PF152AL	Fixador 1615 Fijador 1615 Ref. 2226144

NEON UP NAMAKA IP67

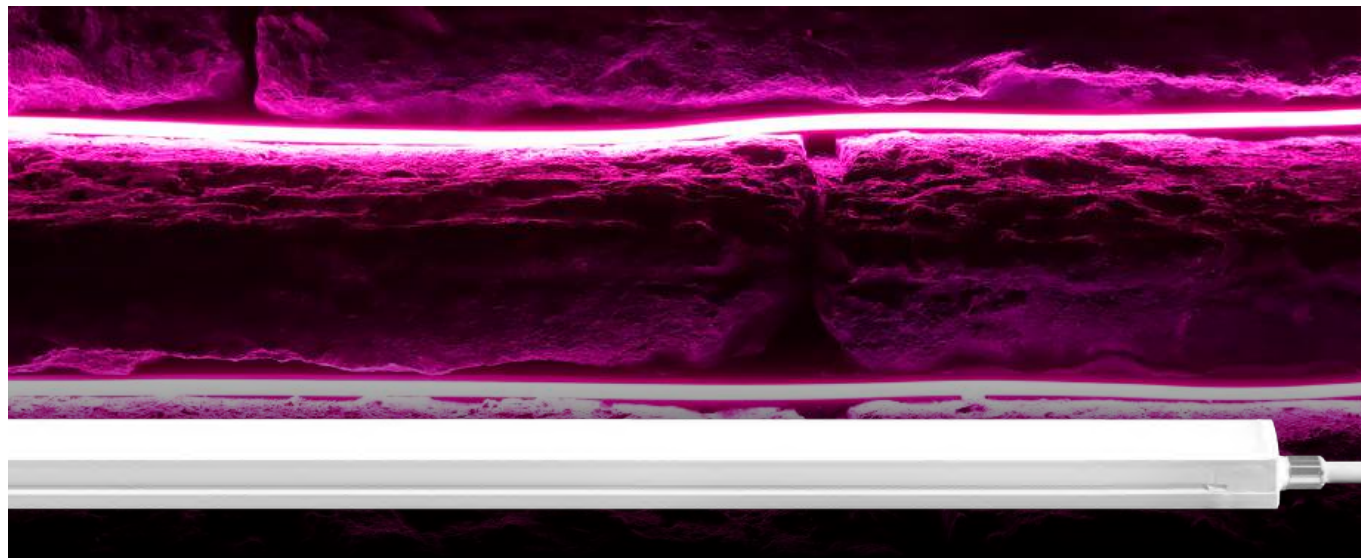

Modelo	Ref.	Cor Color	Tensão Tensión	IP	Numens /mt
NAMAKA L80 50000H 1Bin	136246.11RGB	RGB	24V	IP67	R: 625Nm G: 532Nm B: 475Nm
	1313116.15RGBWW	RGB + 3000K	24V	IP67	407Lm

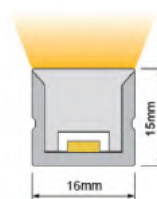
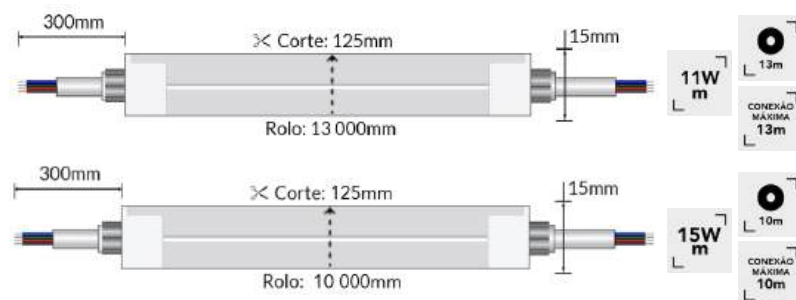

Este modelo standard tem saída de cabo de topo.
Este modelo estándar tiene una salida de cable superior.



ACESSÓRIOS RECOMENDADOS | ACCESORIOS RECOMENDADOS

Tampa final Tapa final Ref. 2219244	Tampa final Tapa final Ref. 2219253	Conector Ref. 2220244.RGB	Calha fixadora PL 1mt Perfil de fijación PL 1mt Ref. PF152PL	Calha fixadora AL 1mt Perfil de fijación AL 1mt Ref. PF152AL	Fixador 1615 Fijador 1615 Ref. 2226144

NEON UP AUTONOE 10W IP67



Modelo	Ref.	Cor Color	Tensão Tensión	IP	Lumens /mt	Lumens /w
AUTONOE L70B10 54000H	1324116.1027	2700K	24V	IP67	776Lm	78Lm
	1324116.1030	3000K	24V	IP67	797Lm	80Lm
	1324116.1040	4000K	24V	IP67	825Lm	83Lm
	1324116.10RGBWW	RGB + 3000K	24V	IP67	749Lm	50Lm

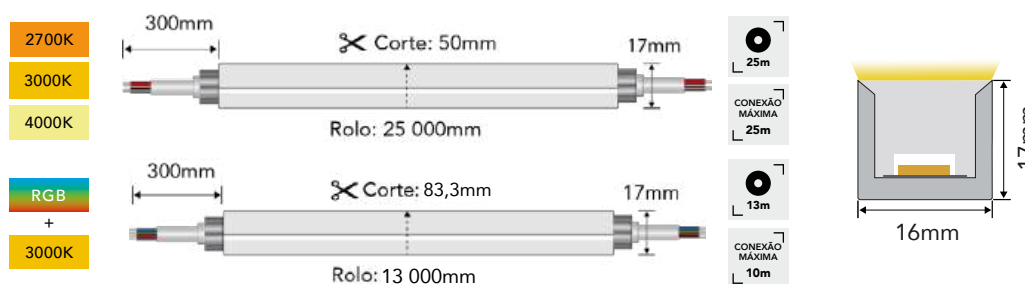

Este modelo standard tem saída de cabo de topo.
Este modelo estándar tiene una salida de cable superior.



ACESSÓRIOS RECOMENDADOS | ACCESORIOS RECOMENDADOS

<p>Calha Fixadora Perfil Fijación AL/PL 1mt AL Ref. PF190AL PL Ref. PF196PL</p>	<p>Calha Fixad. Flex. Perfil Fijación flex. AL 1mt / 2mt Ref. PF1890IX Ref. PF1890IX.2</p>	<p>Perfil Flexível Side Perfil Flexible Side Pavimento 1617 Ref. PF2290IX</p>	<p>Difusor Silicone Difusor Silicona Ref. DF2290SL</p>	<p>Perfil Flexível Enc. Perfil Flexible. Enc. c/ 2 Aba AL 2mt Ref. PF22901</p>	<p>Perfil Flexível Enc. Perfil Flexible. Enc. c/ 1 Aba AL 2mt Ref. PF23901</p>	<p>Fixador Fijador AL/PL 1617 AL Ref. 2226171 PL Ref. 2226272</p>
---	--	---	--	--	--	---

NEON SIDE NÁIADE 10W IP67



Modelo	Ref.	Cor Color	Tensão Tensión	IP	Lumens /mt	Lumens /w
NÁIADE L70B10 54000H 2 Steps MacAdam	132256.1027	2700K	24V	IP67	324Lm	32Lm
	132256.1030	3000K	24V	IP67	346Lm	35Lm
	132256.1040	4000K	24V	IP67	346Lm	35Lm
NÁIADE L80 30000H 1BIN	136256.11RGB	RGB	24V	IP67	R: 625Nm G: 532Nm B: 475Nm	-

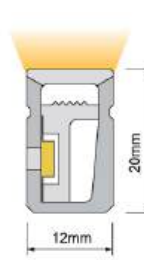
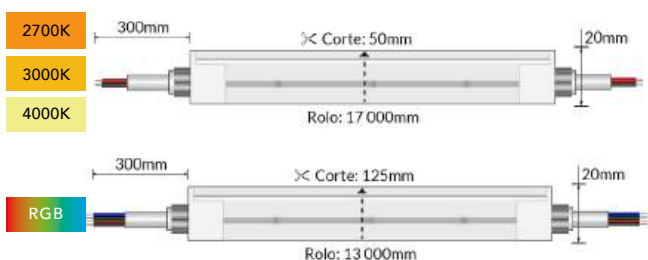

Este modelo standard tem saída de cabo de topo.
Este modelo estándar tiene una salida de cable superior.



ACESSÓRIOS RECOMENDADOS | ACCESORIOS RECOMENDADOS

Tampa final Tapa final Ref. 2219247	Tampa final Tapa final Ref. 2214226	Conector Ref. 2220247	Calha fixadora Perfil de fijación AL 1mt Ref. PF151AL	Fixador 1220 Fijador 1220 Ref. 2226147	Calha fixadora flexível inox Perfil de fijación flexible de acero inoxidable Ref. PF151IX - 0,5mt Ref. PF151IX.1 - 1mt

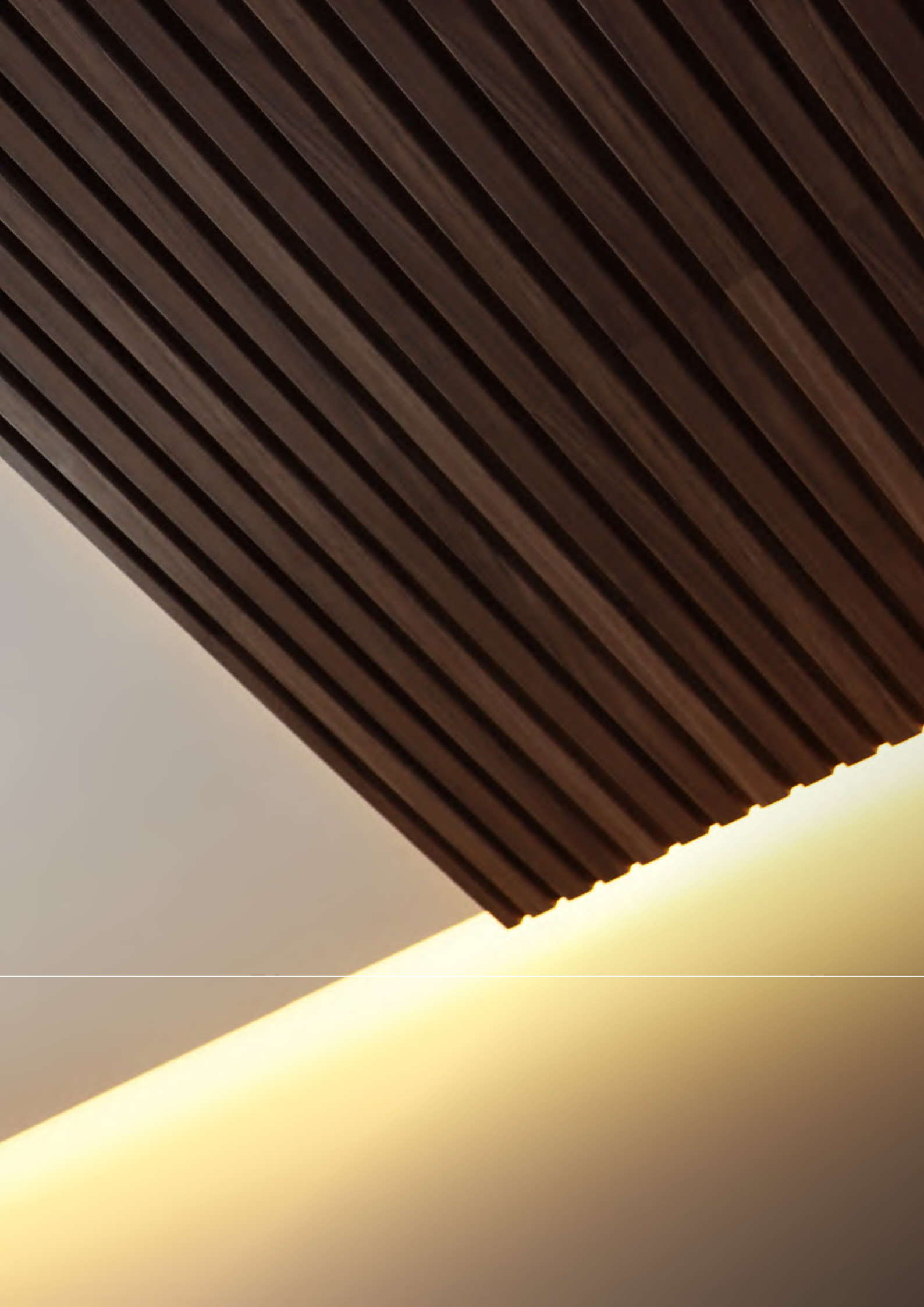

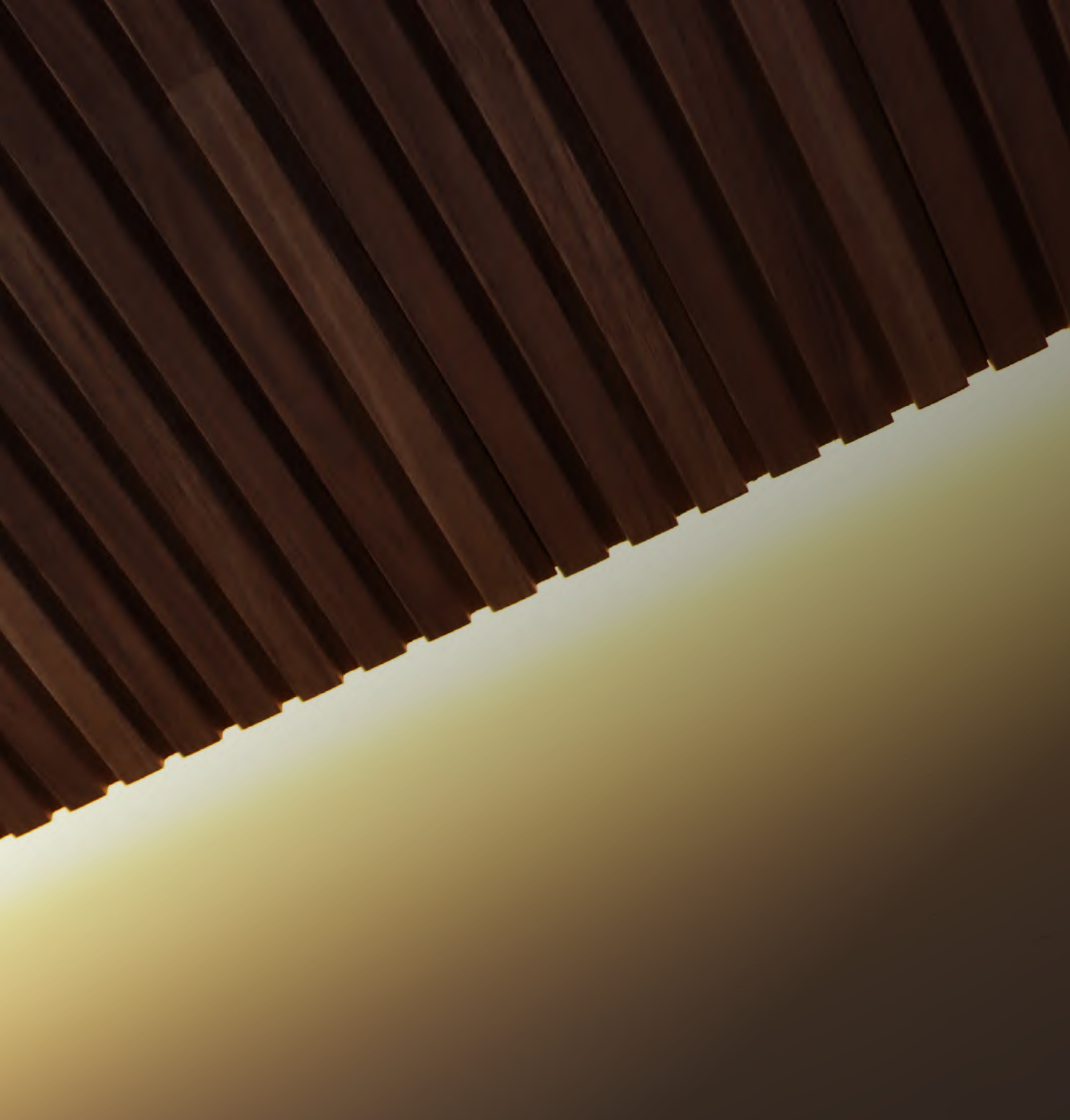

FITAS LED

Tiras Led

ELARA/HIGH ELARA 9,6W IP20



Modelo	Ref.	Efic.	Cor Color	Tensão Tensión	IP	Lumens /mt	Lumens /w
HIGH ELARA L70B50 50000h	13111191.0927	E	2700K	24V	IP20	1240Lm	129Lm
	13111191.0930	E	3000K	24V	IP20	1270Lm	132Lm
	13111191.0940	D	4000K	24V	IP20	1410Lm	147Lm
ELARA* L70B50 36000h	132141.0927*	G	2700K	24V	IP20	860Lm	90Lm
	132141.0930*	G	3000K	24V	IP20	870Lm	91Lm
	132141.0940*	F	4000K	24V	IP20	920Lm	96Lm
3 Steps MacAdam	132141.0960*	F	6000K	24V	IP20	920Lm	96Lm

160 LED/m

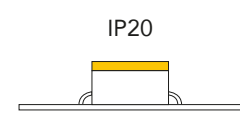

120 LED/m

*NOTA: Após descontinuação a fita Elara (132141.09XX) terá como alternativa a fita High Elara (13111191.09XX).
Tras la discontinuación de la cinta Elara (132141.09XX), la alternativa será la cinta High Elara (13111191.09XX).

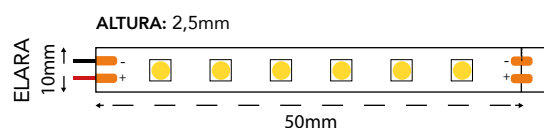

SUGESTÕES | SUGERENCIAS

Perfil Loulé
Ref. PFA8821
Pág. 452

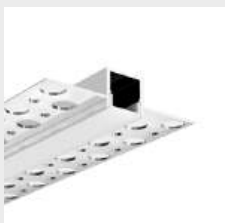

Filtro de Proteção
12-48Vdc 5A 8A Cor Simples
Filtro de Protección Color Simple
Ref. 2238279.8192



ELARA 65/ ELARA 67 9,6W IP65 | IP67

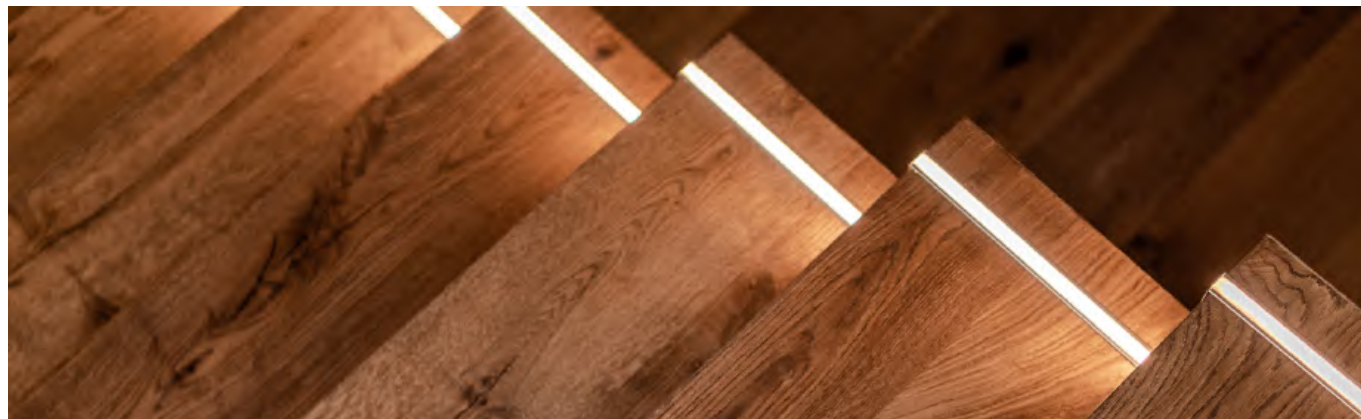

IP65 | IP67



Modelo	Ref.	Efic.	Cor Color	Tensão Tensión	IP	Lumens /mt	Lumens /w
ELARA 65 L70B50 36000h 3 Steps MacAdam	131145.0927	E	2700K	24V	IP65	1170Lm	122Lm
	131145.0930	E	3000K	24V	IP65	1260Lm	131Lm
	131145.0940	E	4000K	24V	IP65	1280Lm	133Lm
ELARA 67 L70B50 36000h	131146.0927	F	2700K	24V	IP67	1030Lm	107Lm
	131146.0930	F	3000K	24V	IP67	1080Lm	113Lm
	131146.0940	D	4000K	24V	IP67	1200Lm	125Lm
	131146.0960	D	6000K	24V	IP67	1250Lm	130Lm

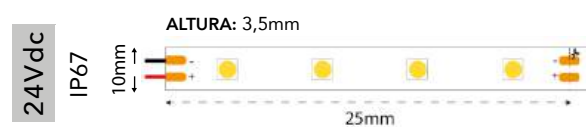
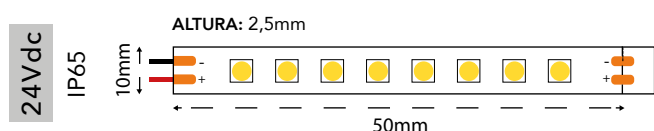
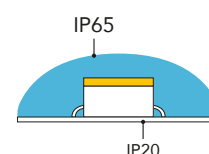

SUGESTÕES | SUGERENCIAS

Perfil Dual
Ref. PFA1601
Pág. 418



LUMINES LIGHTING

Filtro de Proteção
12-48Vdc 5A 8A Cor Simples
Filtro de Protección Color Simple
Ref. 2238279.8192



COB CARPO 10W IP20

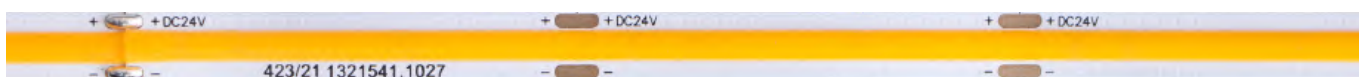

Modelo	Ref.	Efic.	Cor Color	Tensão Tensión	IP	Lumens /mt	Lumens /w
COB CARPO	1321511.1027	F	2700K	12V	IP20	720Lm	72Lm
	1321511.1030	G	3000K	12V	IP20	800Lm	80Lm
	1321511.1040	F	4000K	12V	IP20	850Lm	85Lm
	1321511.1060	F	6000K	12V	IP20	890Lm	89Lm
COB CARPO L70B50 54000H 1 Steps MacAdam	1321541.1027	F	2700K	24V	IP20	960Lm	96Lm
	1321541.1030	G	3000K	24V	IP20	910Lm	91Lm
	1321541.1040	F	4000K	24V	IP20	1060Lm	106Lm
COB CARPO 50M	13255341.1027	F	2700K	24V	IP20	960Lm	96Lm
	13255341.1030	G	3000K	24V	IP20	910Lm	91Lm
	13255341.1040	F	4000K	24V	IP20	1060Lm	106Lm

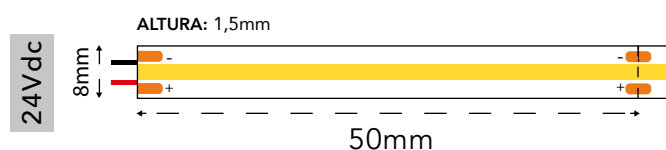
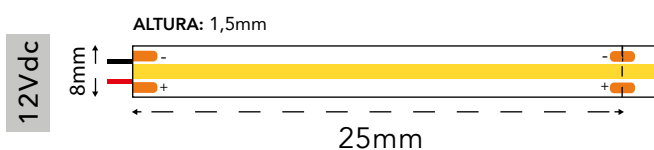
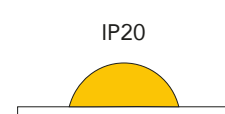

DESTAQUE | DESTACADO

Gama STANDARD

20 M O T A K O

EUROPA 12W IP20



Modelo	Ref.	Efic.	Cor Color	Tensão Tensão	IP	Lumens /mt	Lumens /W
EUROPA L70B50 36000H 3 Steps MacAdam	13011.1227	G	2700K	12V	IP20	1050Lm	88Lm
	13011.1230	G	3000K	12V	IP20	1100Lm	92Lm
	13011.1240	F	4000K	12V	IP20	1140Lm	95Lm
	13011.1260	F	6000K	12V	IP20	1200Lm	100Lm
	13041.1227	G	2700K	24V	IP20	1050Lm	88Lm
	13041.1230	G	3000K	24V	IP20	1100Lm	92Lm
EUROPA 50M L70B50 36000H	1301341.1227	G	2700K	24V	IP20	1030Lm	86Lm
	1301341.1230	G	3000K	24V	IP20	1120Lm	87Lm
	1301341.1240	G	4000K	24V	IP20	1060Lm	88Lm
	1301341.1260	G	6000K	24V	IP20	1200Lm	88Lm

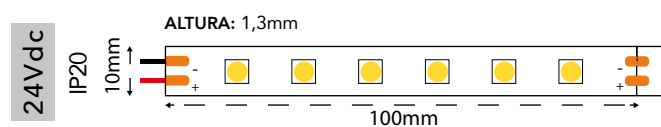
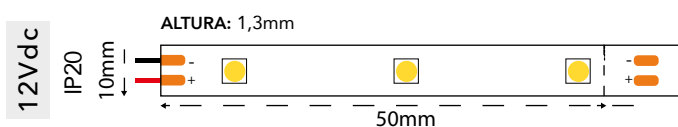
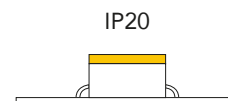

SUGESTÕES | SUGERENCIAS

Perfil Alcoutim
Ref. PFG23100
Pág. 427



Filtro de Proteção
12-48Vdc 5A 8A Cor Simples
Filtro de Protección Color Simple
Ref. 2238279.8192



EUROPA 12W IP65

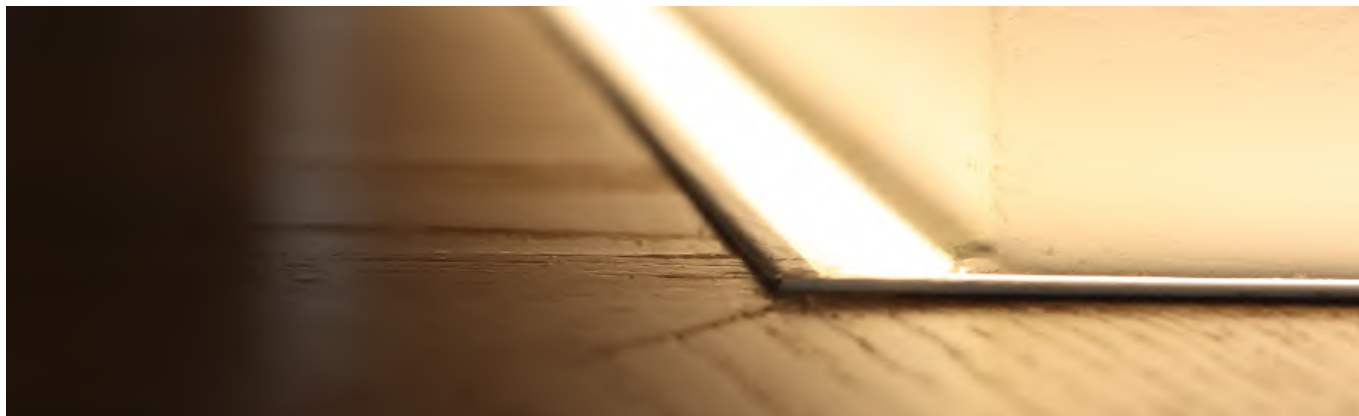

Modelo	Ref.	Efic.	Cor Color	Tensão Tensión	IP	Lumens /mt	Lumens /W
EUROPA 65 L70B50 50000H	13015.1227	G	2700K	12V	IP65	980Lm	82Lm
	13015.1230	G	3000K	12V	IP65	1000Lm	83Lm
	13015.1240	G	4000K	12V	IP65	1086Lm	91Lm
	13015.1260	G	6000K	12V	IP65	1080Lm	90Lm
	13045.1227	G	2700K	24V	IP65	980Lm	82Lm
	13045.1230	G	3000K	24V	IP65	1000Lm	83Lm
	13045.1240	G	4000K	24V	IP65	1085Lm	90Lm
	13045.1260	G	6000K	24V	IP65	1085Lm	90Lm

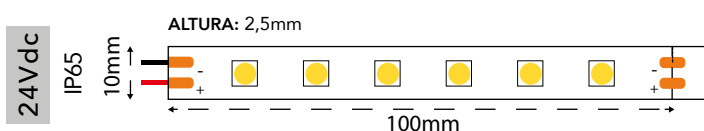
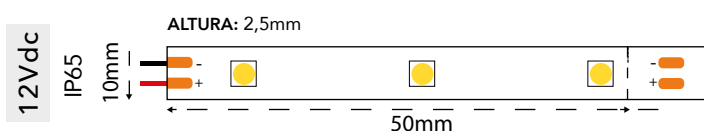
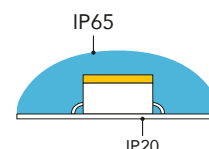

SUGESTÕES | SUGERENCIAS

Perfil Ansiães
Ref. PFG02032
Pág. 445



*Os modelos IP65 apresentam um fluxo luminoso (lumens) inferior aos modelos IP20 devido ao seu revestimento de silicone para proteção de sobre aquecimento.

*Los modelos IP65 tienen un flujo luminoso (Lúmenes) menor que los modelos IP20 debido a su revestimiento de silicona para proteger del sobrecalentamiento.

EUROPA 12W IP68



* ESTA FITA LED NÃO INCLUI FITA ADESIVA
Esta tira de led no incluye cinta adhesiva.



Modelo	Ref.	Efic.	Cor Color	Tensão Tensión	IP	Lumens /mt	Lumens /W
EUROPA 68	13017.1230	G	3000K	12V	IP68	1000Lm	83Lm
	13017.1240	G	4000K	12V	IP68	1085Lm	90Lm
	13017.1260	G	6000K	12V	IP68	1085Lm	90Lm
L70B50 50000H	13047.1230	G	3000K	24V	IP68	1000Lm	83Lm
	13047.1240	G	4000K	24V	IP68	1085Lm	90Lm
	13047.1260	G	6000K	24V	IP68	1085Lm	90Lm

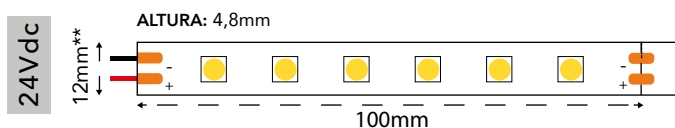
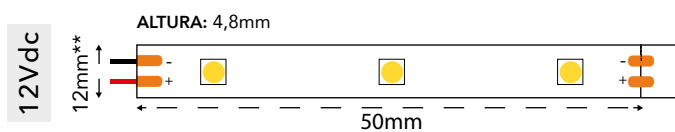
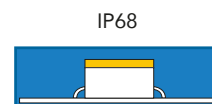

**Disponível também em 10mm
**También disponible en 10mm

*Os modelos IP68 não podem estar no ambiente aquático químico ou salobro.

*Los modelos IP68 no pueden estar en ambientes acuáticos químicos o salobros.

SUGESTÕES | SUGERENCIAS

Fonte Alimentação | Fuente Alimentación IP44
Ref. 201689.2100
Pág. 275



Filtro de Proteção Cor Simple 12-48Vdc 5A 8A
Filtro de Protección Color Simple
Ref. 2238279.8192



NOVA EUROPA 9,6W IP20



9,6W/m
IP20
CRI 90
20Z
2835 LED
128 LED/m
5m
CONEXÃO MÁXIMA 5m
DIMÁVEL
M M
CE
NOVO NUEVO

Modelo	Ref.	Efic.	Cor Color	Tensão Tensión	IP	Lumens /mt	Lumens /w
NOVA EUROPA	13401441.0927	E	2700K	24V	IP20	1248Lm	130Lm
	13401441.0930	E	3000K	24V	IP20	1325Lm	138Lm
	13401441.0940	E	4000K	24V	IP20	1373Lm	143Lm
L70B50 50000H	13401441.0960	E	6000K	24V	IP20	1373Lm	143Lm
	13401341.0927	E	2700K	24V	IP20	1248Lm	130Lm
NOVA EUROPA 50MT	13401341.0930	E	3000K	24V	IP20	1325Lm	138Lm
	13401341.0940	E	4000K	24V	IP20	1373Lm	143Lm
L70B50 50000H	13401341.0960	E	6000K	24V	IP20	1373Lm	143Lm

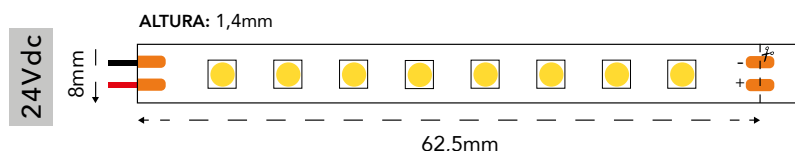
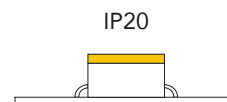

Alternativa às referências :13041.12XX e 1301341.12XX após descontinuação.
 Alternativa a las referencias 13041.12XX e 1301341.12XX después de la discontinuación.

ACESSÓRIOS RECOMENDADOS | ACCESORIOS RECOMENDADOS

<p>Perfil Tipo D Anodizado 2m Ref. PFA1191 Pág. 412</p>	<p>Controlador DIM 12-48Vdc Push DIM / Mesh 2.4G Ref. 2131218.6192 Pág. 362</p>	<p>Filtro de Proteção Cor Simples 12-48Vdc 5A 8A Filtro de Protección Color Simple Ref. 2238279.8192</p>
---	---	--

NOVA EUROPA 9,6W IP65 | IP67



9,6W/m | IP65 | IP67 | CRI 90 | 20Z | 2835 LED | 128 LED/m | 5m | CONEXÃO MÁXIMA 5m | DIMÁVEL | M M | CE | NOVO NUEVO

Modelo	Ref.	Efic.	Cor Color	Tensão Tensión	IP	Lumens /mt	Lumens /w
NOVA EUROPA IP65	13401445.0927	E	2700K	24V	IP65	1248Lm	130Lm
	13401445.0930	E	3000K	24V	IP65	1325Lm	138Lm
	13401445.0940	E	4000K	24V	IP65	1373Lm	143Lm
L70B50 50000H	13401445.0960	E	6000K	24V	IP65	1373Lm	143Lm
	13401447.0927	E	2700K	24V	IP67	1248Lm	130Lm
NOVA EUROPA IP67	13401447.0930	E	3000K	24V	IP67	1325Lm	138Lm
	13401447.0940	E	4000K	24V	IP67	1373Lm	143Lm
L70B50 50000H	13401447.0960	E	6000K	24V	IP67	1373Lm	143Lm

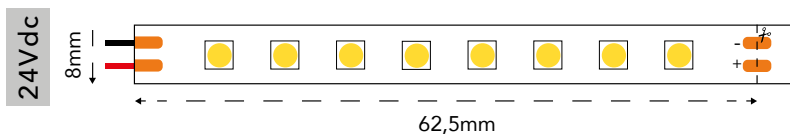
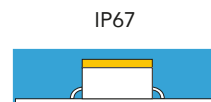
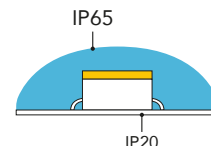

Alternativa às referências 13045.12XX e 13047.12XX após descontinuação.
 Alternativa a las referencias 13015.12XX e 13045.12XX después de la discontinuación.

ACESSÓRIOS RECOMENDADOS | ACCESORIOS RECOMENDADOS

<p>Perfil Alba Anodizado 2m Ref. PFA201001 Pág. 422</p> 	<p>Fonte VTS Eagle Rise 12Vdc 100W 8,33A IP67 Ref. 2018352.1100 Pág. 272</p> 	<p>Filtro de Proteção Cor Simples 12-48Vdc 5A 8A Filtro de Protección Color Simple Ref. 2238279.8192</p> 
---	--	---

GALATEIA 14,4W IP20

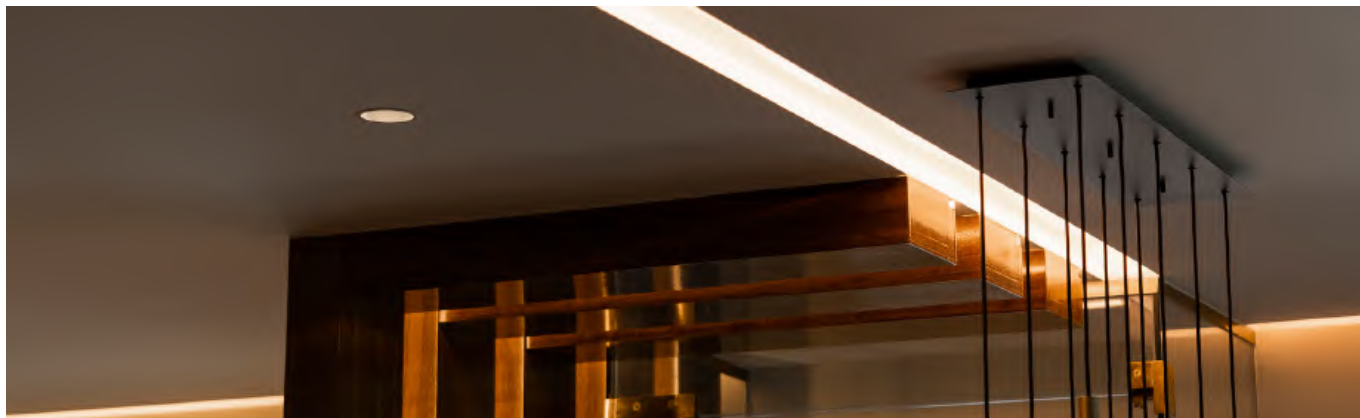

EF+
14,4W/m
IP20
20Z
2835 SMD
160 LED/m
2230 Lm/m
155 Lm/W
5m
CONEXÃO MÁXIMA 5m
DIMÁVEL
CRI 80
M M
CE

Modelo	Ref.	Efic.	Cor Color	Tensão Tensión	IP	Lumens /mt	Lumens /w	
GALATEIA	1311121.1427	E	2700K	24V	IP20	1930Lm	134Lm	
	1311121.1430	E	3000K	24V	IP20	2080Lm	144Lm	
	L70B50 50000H	D	4000K	24V	IP20	2160Lm	150Lm	
	1311121.1460	D	6000K	24V	IP20	2230Lm	155Lm	
GALATEIA 50M	13111341.1427	E	2700K	24V	IP20	1930Lm	134Lm	
	13111341.1430	E	3000K	24V	IP20	2080Lm	144Lm	
	L70B50 50000H	D	4000K	24V	IP20	2160Lm	150Lm	
	13111341.1460	D	6000K	24V	IP20	2230Lm	155Lm	

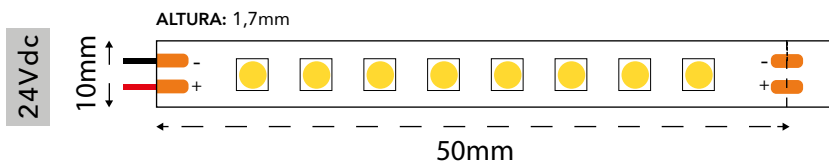

SUGESTÕES | SUGERENCIAS

Controlador 1 Canal 5A
Ref. 2127258.4120
Pág. 369



Filtro de Proteção
12-48Vdc 5A 8A Cor Simples
Filtro de Protección Color Simple
Ref. 2238279.8192



POLIDEUCES 15W IP20



Modelo	Ref.	Efic.	Cor Color	Tensão Tensión	IP	Lumens /mt	Lumens /w
POLIDEUCES L70B50 50000H 3 Steps MacAdam	131521.1527	F	2700K	24V	IP20	1460Lm	97Lm
	131521.1530	F	3000K	24V	IP20	1480Lm	99Lm
	131521.1540	F	4000K	24V	IP20	1560Lm	104Lm
	131521.1550	F	5000K	24V	IP20	1560Lm	104Lm
	131521.1560	F	6500K	24V	IP20	1560Lm	104Lm

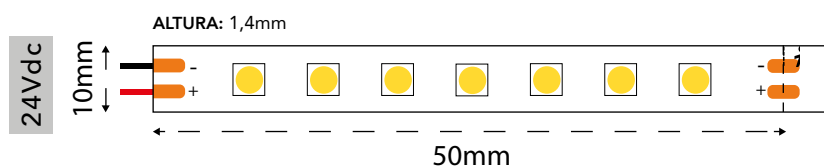
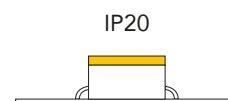

SUGESTÕES | SUGERENCIAS

Controlador dimmer
RF+Wifi+Push Nexta
Ref. 2127258.4240
Pág. 369



_ Controlador ideal para controlar fitas LED de 12Vdc e 24Vdc, até uma potência máxima de 120W (12Vdc) e 240W (24Vdc);

_ Este permite ser controlado por Wifi, RF e push.

_ Controlador ideal para controlar tiras LED de 12Vdc y 24Vdc, hasta una potencia máxima de 120W (12Vdc) y 240W (24Vdc);

_ Este permite ser controlado por Wifi, RF y push.

POLIDEUCES 15W IP54 | IP65



Modelo	Ref.	Efic.	Cor Color	Tensão Tensión	IP	Lumens /mt	Lumens /W
POLIDEUCES 54 L70B10 50000H 5 Steps MacAdam	13324.1527	E	2700K	24V	IP54	2100Lm	140Lm
	13324.1530	E	3000K	24V	IP54	2160Lm	144Lm
	13324.1540	D	4000K	24V	IP54	2240Lm	149Lm
POLIDEUCES 65 L70B50 36000H 3 Steps MacAdam	131525.1527	F	2700K	24V	IP65	1440Lm	96Lm
	131525.1530	F	3000K	24V	IP65	1460Lm	97Lm
	131525.1540	F	4000K	24V	IP65	1480Lm	99Lm
	131525.1560	F	6500K	24V	IP65	1560Lm	104Lm

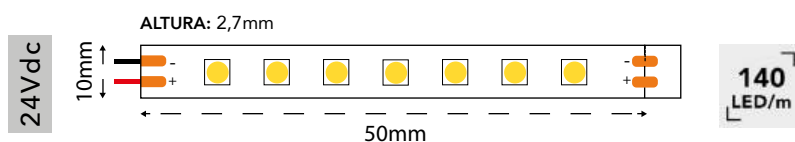
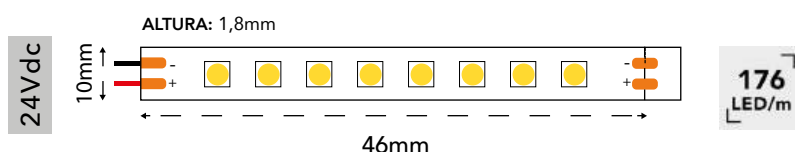
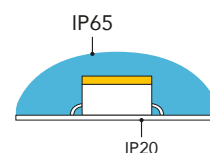

SUGESTÕES | SUGERENCIAS

Controlador dimmer
RF+Wifi+Push Nexta
Ref. 2127258.4240
Pág. 369



Filtro de Proteção
12-48Vdc 5A 8A Cor Simples
Filtro de Protección Color Simple
Ref. 2238279.8192



NOVA POLIDEUCES 15W IP20



15W/m
24V DC
IP20
CRI 90
2835 LED
160 LED/m
5m
CONEXÃO MÁXIMA 5m
DIMÁVEL
M M
CE
NOVO NUEVO

Modelo	Ref.	Efic.	Cor Color	Tensão Tensión	IP	Lumens /mt	Lumens /w
NOVA POLIDEUCES L80B10 50000H	13111461.1527		2700K	24V	IP20	2220Lm	148Lm
	13111461.1530		3000K	24V	IP20	2250Lm	150Lm
	13111461.1540		4000K	24V	IP20	2295Lm	153Lm
	13111461.1560		6500K	24V	IP20	2295Lm	153Lm

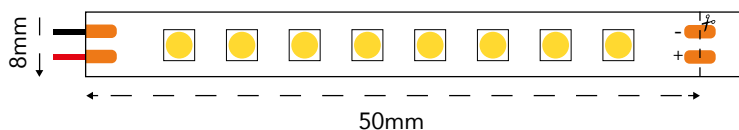
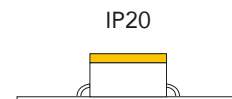

SUGESTÕES | SUGERENCIAS

Perfil Andorra
Ref. PFA111
Pág. 413

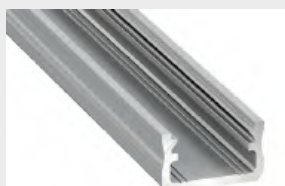

Controlador Mini Dim
Push RF/WiFi 12-48V
Ref. 2130218.6144
Pág. 339



COB CALICORE 15W IP65



Modelo	Ref.	Efic.	Cor Color	Tensão Tensão	IP	Lumens /mt	Lumens /w
COB CALICORE 50000H 6 Steps MacAdam	1328525.1527		2700K	24V	IP65	1605Lm	107Lm
	1328525.1530		3000K	24V	IP65	1725Lm	115Lm
	1328525.1540	G	4000K	24V	IP65	1875Lm	125Lm
	1328525.1560	F	6500K	24V	IP65	1800Lm	120Lm

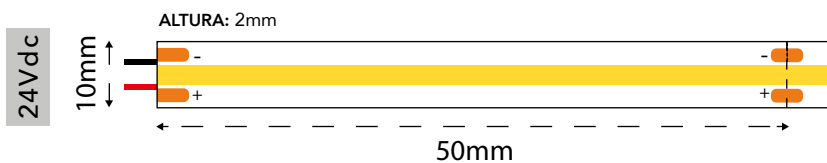
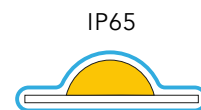

SUGESTÕES | SUGERENCIAS

Perfil Monsaraz
Ref. PFD5361
Pág. 447



Filtro de Proteção
12-48Vdc 5A 8A Cor Simples
Filtro de Protección Color Simple
Ref. 2238279.8192



AEGIR 14,4W IP68

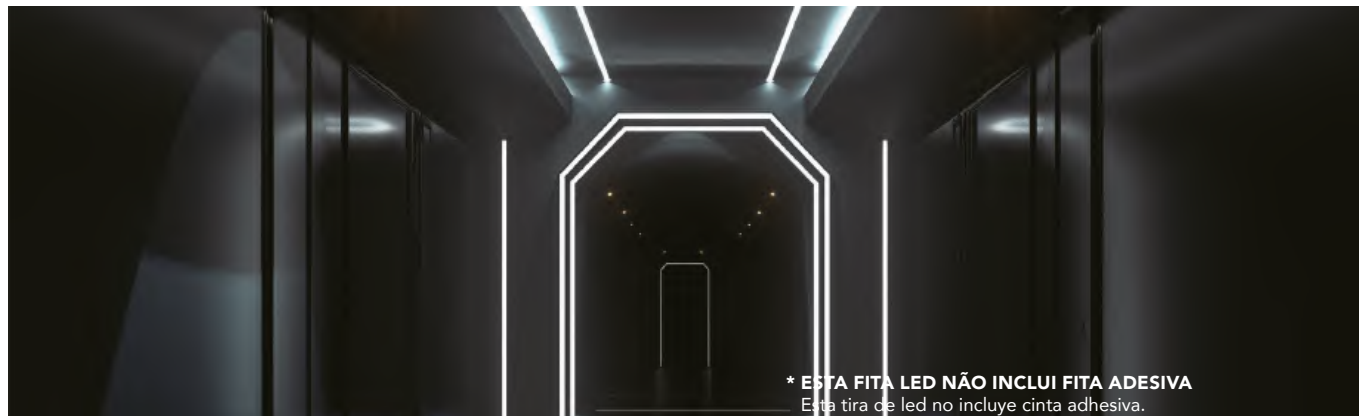

* ESTA FITA LED NÃO INCLUI FITA ADESIVA
Esta tira de led no incluye cinta adhesiva.



Modelo	Ref.	Efic.	Cor Color	Tensão Tensión	IP	Lumens /mt	Lumens /w
AEGIR L70B50 36000H	1312157.1430	F	3000K	24V	IP68	1650Lm	115Lm
	1312157.1440	E	4000K	24V	IP68	1850Lm	128Lm
	1312157.1460	E	6000K	24V	IP68	1780Lm	124Lm

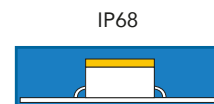

SUGESTÕES | SUGERENCIAS

Difusor em rolo*
Difusor en rollo*
Pág. 402



Filtro de Proteção
12-48Vdc 5A 8A Cor Simples
Filtro de Protección Color Simple
Ref. 2238279.8192



*Consiga uma linha de luz contínua com o nosso difusor em rolo de 50mt.

*Consiga una línea continua de luz con nuestro difusor en rollo de 50mt.



Consulte fichas técnicas, certificados e ficheiros IES (Dialux) no nosso website.

Consulta ficha técnica, certificados y expedientes IES (Dialux) en nuestra página web.

A modern living room with a large window and a potted plant. The room is brightly lit, with a warm orange glow from a recessed light fixture above the window. A tall, green potted plant stands to the left of the window. The window looks out onto a balcony with a railing and some outdoor furniture. The overall atmosphere is clean, bright, and contemporary.

FONTES DE ALIMENTAÇÃO

Fuentes de Alimentación

REF. 201561.XXXX



REF.	TENSÃO	POTÊNCIA	INPUT	MODELO	DIMENSÕES (CxLxA)
201561.16	12V	6W	176-264Vac	Fonte de Alimentação Mini	168x38x30mm
201561.26	24V	6W	176-264Vac		
201561.130	12V	30W	198-264Vac	Driver LED Tensão Constante	160x42x30mm
201561.160		60W	176-264Vac		
201561.175		75W	176-264Vac		
201561.230	24V	30W	198-264Vac	Driver LED Tensão Constante	160x42x30mm
201561.260		60W	176-264Vac		
201561.275		75W	176-264Vac		
201561.2120	48V	120W	198-264Vac	Driver LED Tensão Constante	268x42x30mm
201561.2150		150W	198-264Vac		
201561.2200		200W	198-264Vac		
201561.2250		250W	198-264Vac		
201561.775	48V	75W	198-264Vac	Driver LED Tensão Constante	168x38x30mm
201561.7150		150W	198-264Vac		
201561.7200		200W	198-264Vac		
201561.7250		250W	198-264Vac		



REF. 201176.XXXX



REF.	TENSÃO	POTÊNCIA	INPUT	MODELO	DIMENSÕES (CxLxA)
201176.120	12V	20W	90-264Vac	Fonte LPV	118x35x26mm
201176.135		35W	90-264Vac		148x40x30mm
201176.160		60W	90-264Vac		162,5x42,5x32mm
201176.1100		100W	90-264Vac		190x52x37mm
201176.1150		120W	180-305Vac		191x63x37,5mm
201176.220	24V	20W	90-264Vac	Fonte LPV	118x35x26mm
201176.235		35W	90-264Vac		148x40x30mm
201176.260		60W	90-264Vac		162,5x42,5x32mm
201176.2100		100W	90-264Vac		190x52x37mm
201176.2150		150W	90-264Vac		191x63x37,5mm

Nota: Outras tensões disponíveis por consulta. | Hay otras tensiones disponibles previa consulta.

REF. 201561.XXXX



REF.	TENSÃO	POTÊNCIA	INPUT	MODELO	DIMENSÕES (CxLxA)
203535.1100	12V	96W	100-305Vac		125x63x32mm
203535.1150	12V	150W	100-305Vac	Fonte XLG	156x63x35,5mm
203535.1200	12V	192W	100-305Vac		175x63x35,5mm
203535.275	24V	75W	100-305Vac		125x63x32mm
203535.2100	24V	96W	100-305Vac		125x63x32mm
203535.2150	24V	150W	100-305Vac	Fonte XLG	156x63x35,5mm
203535.2200	24V	200W	100-305Vac		175x63x35,5mm
203535.2320	12-24V	216W (12V) 312W (24V)	100-305Vac		246x77x39,5mm
203535.7240	48V	240W	100-305Vac		219x63x35,5mm
203535.7320	48V	312W	100-305Vac	Fonte XLG	264x77x39,5mm

Nota: Outras tensões disponíveis por consulta. | Hay otras tensiones disponibles previa consulta.



Corpo em alumínio
Cuerpo de aluminio



Cabo em silicone
Cable de silicona



SMART HOME

Casa Inteligente



REF.	TENSÃO	POTÊNCIA	CORRENTE	Nº CANAIS	CONTROLO	DIMENSÕES (CxLxA)
211218.3400	240V	400W	-	1	Dimmer PUSH	45,5x45x20,3mm
211218.196	12-36V	96W (12Vdc) 192W (24Vdc)	1x8A@12-36Vdc	1	PUSH Dim Cor Simples	95x37x20mm



REF.	TENSÃO	POTÊNCIA	CORRENTE	Nº CANAIS	CONTROLO	FUNÇÃO	DIMENSÕES (CxLxA)
212217.1180*	12-24Vdc	180W (12Vdc) 360W (24Vdc)	5A/CH	3	Controlo RF Até 100 controladores	Controlador RGB	120x47,9x17,6mm
213219.DIM4**	3V (1xCR2025)	-	-	4	Comando RF SR	Comando COR ÚNICA	136,3x38,9x10x7mm

* Vendido em kit (comando + controlador) | Se vende em kit (mando + controlador)

** Comando compatível com todos os controladores da série 211218.XXXX. | Mando compatible con todos controladores de la serie 211218.XXXX



REF.	TENSÃO	POTÊNCIA	CORRENTE	Nº CANAIS	CONTROLO	DIMENSÕES (CxLxA)
211244.4120	12-24V	60W (12V) 120W (24V)	5A	1	2 Botões Dimming	87x35x29mm
211244.4RGB	12-24V	54W (12V) 108W (24V)	1,5A/CH	3	2 Botões RGB	87x35x29mm

*Comandos sugeridos / Comandos sugeridos
 REF.: 2120244.DIM; 2121244.DIM; 2120244.RGBW; 2121244.RGBW; 2120244.RGB+WW; 2119744.8RGBW; 2129744.8DIM; 213144.2CH; 2120178.4PT / 4BR



REF.	TENSÃO	POTÊNCIA	CORRENTE	Nº CANAIS	CONTROLO	FUNÇÃO	DIMENSÕES (CxLxA)
2130218.6144	12-48V	72W (12Vdc) 144W (24Vdc) 180W (36Vdc) 240W (48Vdc)	6A@12/24V 5A@36/48V	1	Push Dim RF/WiFi	Controlador Mini DIM	56x38,50x18mm
2130217.4216	12-24V	3x(36-72)W	9.5A	3	Push Dim RF/WiFi	Controlador Mini RGB	56x38,50x18mm

*Comandos sugeridos / Comandos sugeridos
 REF.: 2120244.DIM; 2121244.DIM; 2120244.RGBW; 2121244.RGBW; 2120244.RGB+WW; 2119744.8RGBW; 2129744.8DIM; 213144.2CH; 2120178.4PT / 4BR

PRODUTO | MODELO

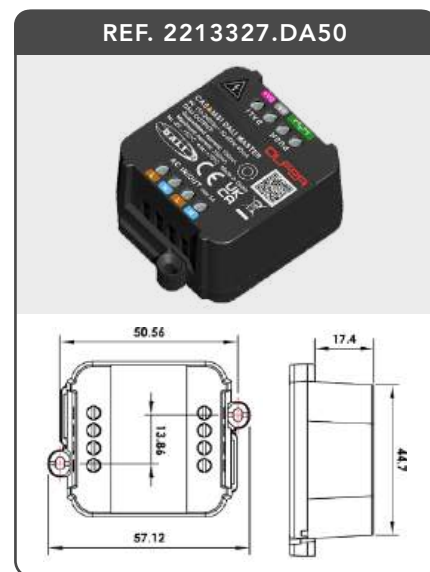
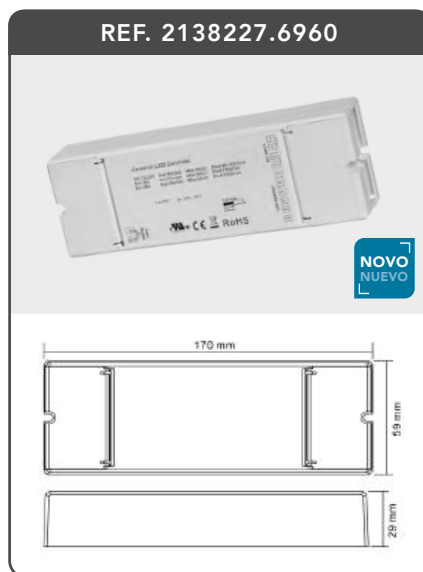
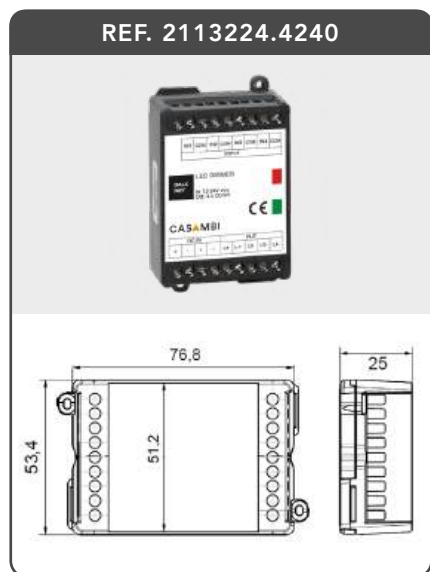

REF.	TENSÃO TENSION	POTÊNCIA POTENCIA	Nº CANAIS N.º CANALES	CONTROLO CONTROL	IP	FUNÇÃO FUNCIÓN
2113224.4240	12-24Vdc	120W/CH (24Vdc)	4	Casambi + 4xPush	IP20	Controlador DIM DIM / CCT / RGB / RGB+W
2138227.6960	12-48Vdc	192W/CH (24Vdc)	5	Casambi + 1xPush	IP20	7 em 1 Controlador DIM DIM / CCT / RGB / RGB+W / RGB +CCT
2213327.DA50	230Vac	-	-	Casambi + 1xPush	IP20	Conversor Casambi - Dali2 (52xDrives, 8xEndereços)

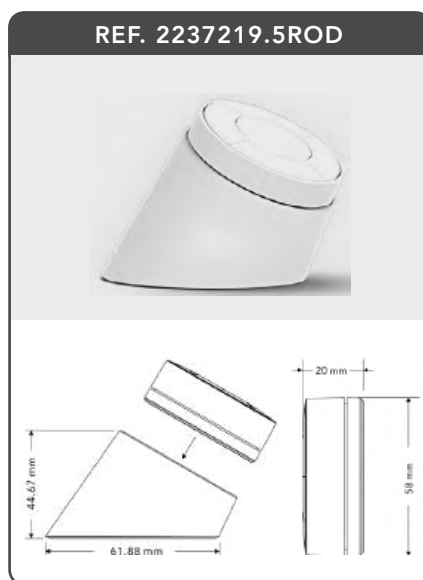
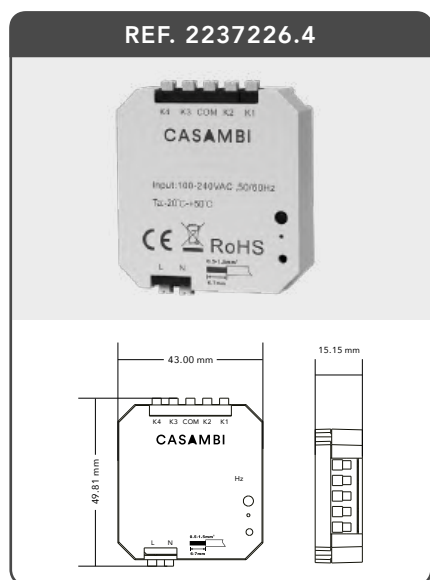

REF.	TENSÃO TENSION	ALCANCE ALCANCE	Nº CANAIS N.º CANALES	CONTROLO CONTROL	IP	FUNÇÃO FUNCIÓN
2237226.4	100-240Vac	50m Campo aberto	4	Push	IP20	Módulo 4 entradas
2237219.5ROD	3Vdc (CR2450)	50m Campo aberto	5	5xBotões + Rotativo 4 Dim + 1 RGBW	IP20	Comando Rotativo + Bot. Mesa/Parede

PERFIS ARQUITETURAIS

Perfiles Arquitectónicos

PERFIS SALIENTES

PERFIL OURÉM

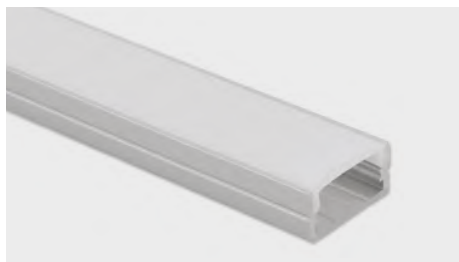

Aplicação | Aplicación: Saliente
 Perfil Saliente baixo s/ abas
 Perfil Saliente bajo s/ solapas

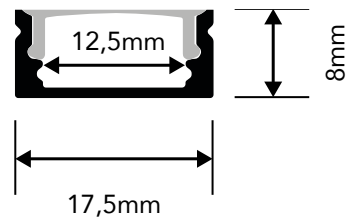

Modelo	Ref.	Cor Color
OURÉM	PF101	Anodizado c/ Difusor Semi-Opalino Anodizado c/ Difusor Semi-Opalino
	PFT101	Anodizado c/ Difusor Transparente Anodizado c/ Difusor Transparente

Modelo	Ref.	Cor Color
TORRE DE OURÉM	PF11011	Perfil Anodizado sem Difusor Perfil Anodizado sin Difusor
	DF15SO*	Difusor Semi-Opalino Difusor Semi-Opalino

Ref.	Acessórios
TP101	Topo final Tapa final
TPF101	Topo c/ passagem de fio Tapa c/ pasacable
FX101	Fixador Metal Fijador Metal

*Disponível em | Disponible en:



PERFIL ARRAIOLOS

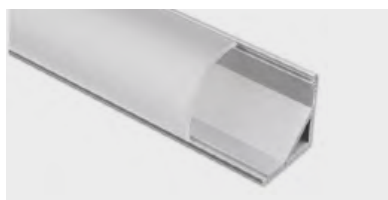

Aplicação | Aplicación:
 Saliente de Canto | Saliente de Esquina

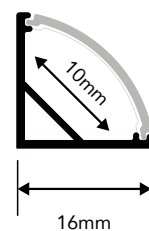

Modelo	Ref.	Cor Color
ARRAIOLOS	PF105	Anodizado c/ Difusor Semi-Opalino Anodizado c/ Difusor Semi-Opalino

Ref.	Acessórios
TP105	Topo final Tapa final
FX105	Fixador Metal Fijador Metal

PERFIS SALIENTES

PERFIL VIDE



Aplicação | Aplicación: Saliente

Perfil Saliente alto s/ abas
 Perfil Saliente alto s/ solapas

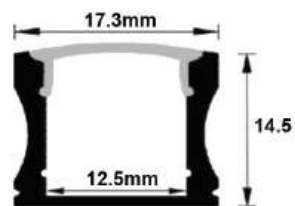

Modelo	Ref.	Cor Color
VIDE	PF102	Anodizado c/ Difusor Semi-Opalino Anodizado c/ Difusor Semi-Opalino
	PFT102	Anodizado c/ Difusor Transparente Anodizado c/ Difusor Transparente

Ref.	Acessórios
TP102	Topo final Tapa final
FX102	Fixador Metal Fijador Metal
FX101	Fixador Metal Fijador Metal

Modelo	Ref.	Cor Color
TORRE DE VIDE	PF11031	Perfil Anodizado sem Difusor Perfil Anodizado sin Difusor
	DF15SO*	Difusor Semi-Opalino Difusor Semi-Opalino

*Disponível em | Disponible en:



DF15SO DF15SO.10 DF15SO.20 DF15SO.50



PERFIS ENCASTRE

PERFIL ESTREMOZ

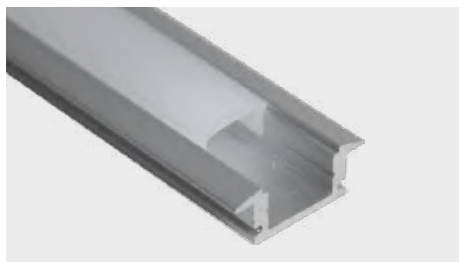

Aplicação | Aplicación: Encastre | Empotrado

Perfil de Encastre baixo c/ abas
Perfil empotrado bajo c/ solapas

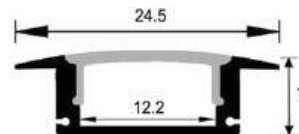

Modelo	Ref.	Cor Color
ESTREMOZ	PF201	Anodizado c/ Difusor Semi-Opalino
	PFT201	Anodizado c/ Difusor Transparente

Modelo	Ref.	Cor Color
TORRE DE ESTREMOZ	PFA21401	Perfil Anodizado s/ Difusor
	DF15SO*	Difusor Semi-Opalino

Ref.	Acessórios
TP201	Topo final Tapa final

*Disponível em | Disponible en:

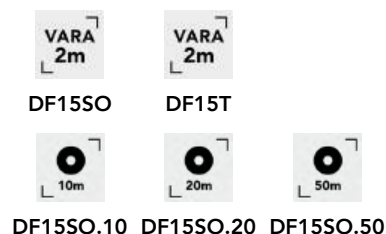

PERFIS BARRAMENTO

PERFIL ALENQUER

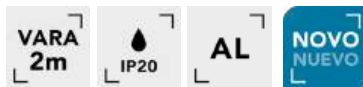

Aplicação | Aplicación: Encastre | Empotrado

Flexível, curvatura up e side.
Flexible, curvatura up y lateral.

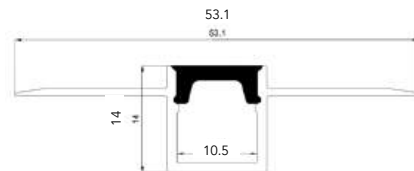

Modelo	Ref.	Cor Color
ALENQUER	PFA18881	Anodizado c/ Difusor Semi-Opalino Anodizado c/ Difusor Semi-Opalino

TP8821	Topo Plástico Cinza Topo Plástico Gris
DFSL8*	Difusor Opalino Silicone Difusor Opalino Silicon

*Disponível em | Disponible en:

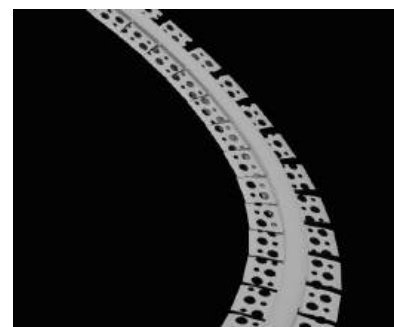

PERFIS BARRAMENTO

PERFIL ALCANEDE

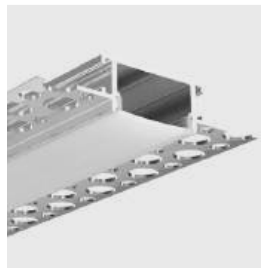

Aplicação | Aplicación:
Encastre | Empotrado

Solução de perfil para instalação em gesso
Solución de perfil para instalación en yeso

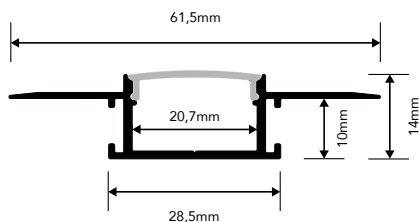

Modelo	Ref.	Cor Color
ALCANEDE	PFA8811	Anodizado c/ Difusor Semi-Opalino Anodizado c/ Difusor Semi-Opalino
	PFA8818	Anodizado c/ Difusor Preto Anodizado c/ Difusor Negro

Modelo	Ref.	Cor Color
TORRE DE ALCANEDE	PFA8941	Perfil Anodizado sem Difusor Perfil Anodizado sin Difusor
	DF9SO*	Difusor Semi-Opalino Difusor Semi-Opalino
	DF9PT*	Difusor Preto Difusor Negro
	DFSL9*	Difusor Opalino Silicone Difusor Opalino Silicona

* Perfil com possibilidade de fazer ângulos.
* Perfil con posibilidad de hacer ángulos.

	Ref.	Acessórios
	TP8811	Topo Plástico Cinza Topo Plástico Gris
	PFA8811.H90	Ângulo 90° na Horizontal Ángulo de 90° en Horizontal
	PFA8811.VI90	Ângulo 90° na Vertical Interior Ángulo de 90° en la Vertical Interior
	PFA8811.VE90	Ângulo 90° na Vertical Exterior Ángulo de 90° en Vertical Exterior

*Disponível em | Disponible en:



DF9SO
DF9PT
DFSL9



DF9SO.10
DF9PT.10
DFSL9.10



DF9SO.50
DF9PT.50
DFSL9.50

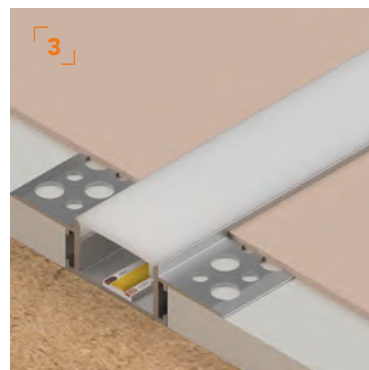
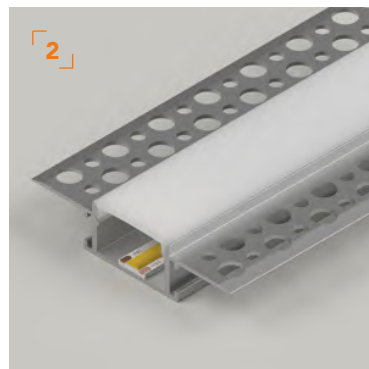
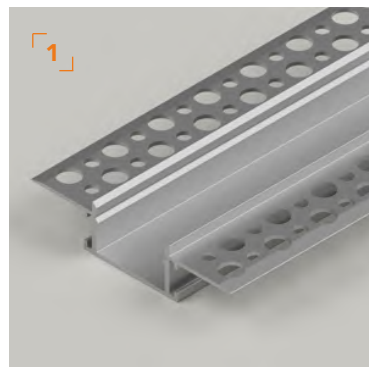

PERFIS DE RODAPÉ / RODATETO

PERFIL LINHARES

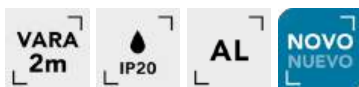
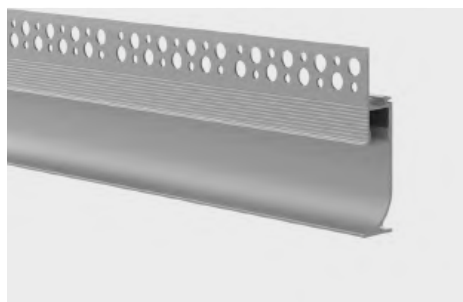

Aplicação | Aplicación:
Rodapé de Encastre | Rodapié Empotrado

Perfil de aplicação encastrada com barramento tornando aba invisível. Ideal para rodapé e de iluminação indireta.
Perfil de aplicación empotrado con busbar que hace invisible la pestaña. Ideal para zócalos y iluminación indirecta.

Modelo	Ref.	Cor Color
LINHARES	PFA81121	Anodizado c/ Difusor Semi-Opalino Anodizado c/ Difusor Semi-Opalino
	PFA81122	Branco c/ Difusor Semi-Opalino Blanco c/ Difusor Semi-Opalino

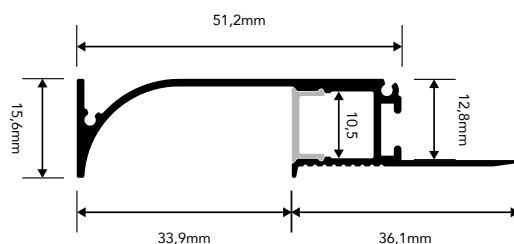

Ref.	Acessórios
TP81121	Kit Plástico Cinza (Dir. e Esq.) Kit Plástico Gris (Der. e Izq.)
TP81122	Kit Plástico Branco (Dir. e Esq.) Kit Plástico Blanco (Der. e Izq.)

PERFIL SESIMBRA

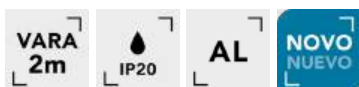

Aplicação | Aplicación:
Rodapé Saliente | Rodapié Saliente

Inclui 2 peças para simplificar a montagem. Este sistema de perfil permite a passagem de cabos oculta. Incluye 2 piezas para simplificar el montaje. Este sistema de perfil permite el paso oculto de cables.

Modelo	Ref.	Cor Color
SESIMBRA	PFA131331	Anodizado c/ Difusor Semi-Opalino Anodizado c/ Difusor Semi-Opalino

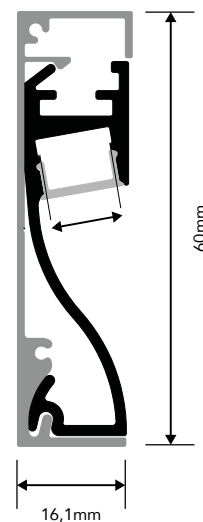

FICHA TÉCNICA

A Elta - Iluminação, Lda. reserva-se no direito de alterar especificações técnicas, bem como atualizar as características dos produtos nas suas fichas técnicas, devido à evolução constante dos produtos. É proibida a reprodução total ou parcial dos elementos gráficos deste catálogo sem autorização prévia da Elta - Iluminação, Lda.

PAGINAÇÃO & DESIGN GRÁFICO
Departamento de Marketing

EMAIL
comercial@motako.pt

WEBSITE
www.motako.pt

PRODUÇÃO
2026

TELEFONE
+351 261 027 304



LED LIGHTING SOLUTIONS

WWW.MOTAKO.PT